



SALICE

Glow Easy • Glow+

POR



Glow Easy • Glow +

Versatilidade e design

- Sistema de deslizamento para armários com 2, 3 ou mais portas sobrepostas
- Ideal para aplicações em dormitórios e salas de estar
- Aplicação discreta e elegante

Desempenho sem compromissos

- Abertura e fechamento desacelerado e controlado
- Movimento fluido, suave e silencioso
- Nenhuma resistência durante o deslizamento
- Compatível com portas de madeira e alumínio
- Capacidade de até 70 kg por porta, com kit de reforço disponível para portas de até 100 kg

Instalação rápida

- Montagem rápida e intuitiva
- Fixação com parafusos ou cliques de pressão (Klik)



Glow Easy • Glow +

Versatilidade e design

Glow Easy e Glow+ são sistemas de deslizamento para armários com 2, 3 ou mais portas sobrepostas, desenvolvidos para aplicações em dormitórios e salas de estar. A fluidez do movimento se combina com uma integração discreta ao móvel, proporcionando um resultado estético limpo e essencial.

Desempenho sem compromissos

O Glow Easy possui um amortecedor a óleo que proporciona uma desaceleração funcional e conforto de uso tanto na abertura quanto no fechamento. O sistema é compatível com portas de madeira e alumínio, com capacidade de até 70 kg por porta, podendo ser ampliada até 100 kg por meio de um kit de reforço específico, mantendo alto desempenho ao longo do tempo.

O inovador amortecedor magnético do Glow+ garante uma desaceleração controlada tanto na abertura quanto no fechamento, assegurando um deslizamento extremamente fluido e silencioso. A ausência de resistência elimina ruídos e melhora significativamente o conforto de uso.

Instalação rápida

Glow Easy e Glow+ são projetados para oferecer máxima simplicidade de instalação, que pode ser realizada por meio de cliques de pressão (Klik), garantindo rapidez e precisão na montagem, ou através de parafusos para reduzir o espaço ocupado.



Informações técnicas

COMPOSIÇÃO DO MECANISMO

- Perfis em alumínio: liga 6060T5, anodizados fosco.
- Rodízios de deslizamento: rolamentos para alta velocidade.
- Carrinhos superiores e inferiores em chapa pintada.
- Componentes internos: plástico e zamak.

CARACTERÍSTICAS DAS PORTAS

- Peso máximo por porta 70 kg.
Com kit de potencialização 100 kg (uniformemente distribuído).
- Espessura subdividida em 6 categorias:
 - 1: até 23 mm;
 - 2: até 26 mm;
 - 3: até 30 mm;
 - 4: até 35 mm;
 - 5: até 40 mm;
 - 6: até 50 mm.
- Altura do piso: 17 mm ou 33 mm.
- Material:
 - a) madeira ou derivados;
 - b) quadro em metal e vidro.

Largura mínima da porta individual Glow Easy:

- 2 portas 600 mm;
- 3 portas 670 mm;
- 2 e 3 portas com kit de reforço 1000 mm.

Largura mínima da porta individual Glow+:

- 2 portas 600 mm;
- 3 portas 830 mm;
- 2 e 3 portas com kit de reforço 1000 mm.

- Regulagem da porta: vertical +5 / -0 mm.

TIPOLOGIA DE ABERTURA

- Disponível para uma, duas, três ou mais portas, cada uma amortizada tanto na abertura como no fechamento.

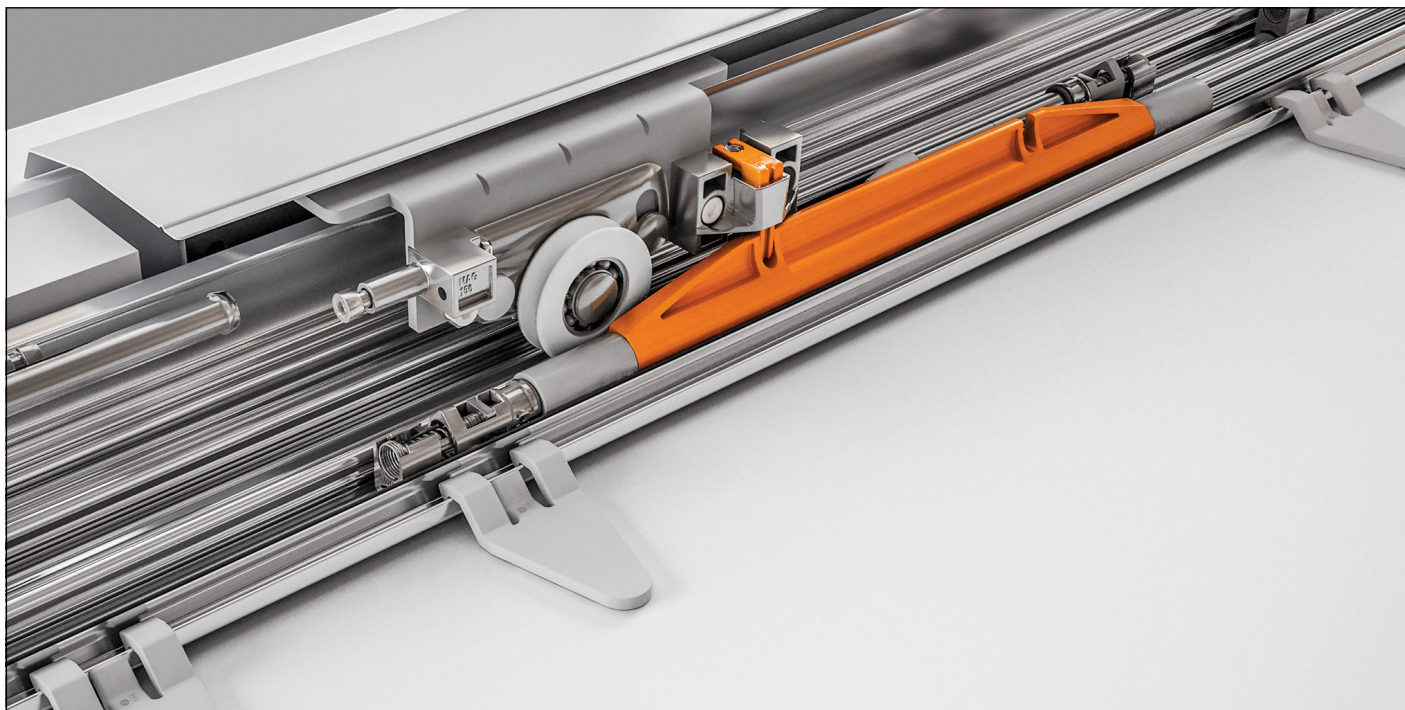

Glow Easy

Características principais

Desaceleração das portas na abertura e no fechamento com amortecedor a óleo.

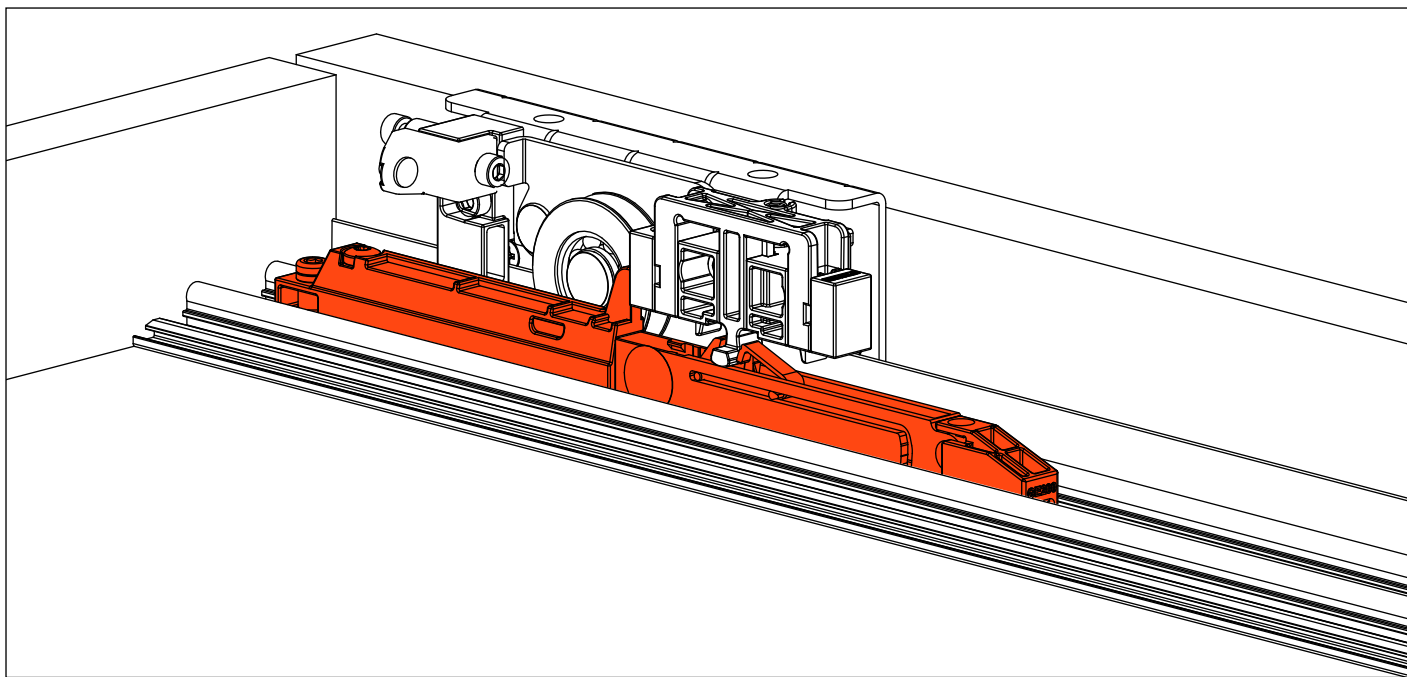

Pino ativador extremamente fácil de montar e reposicionar.

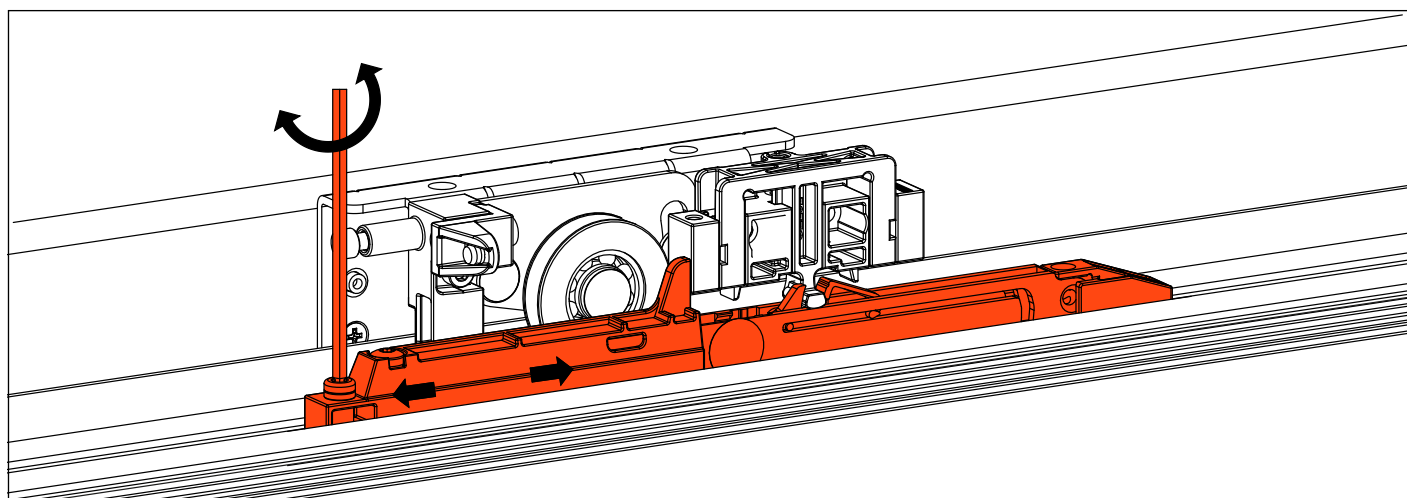

Gancho automático, com rearme, entre o carrinho e o amortecedor.

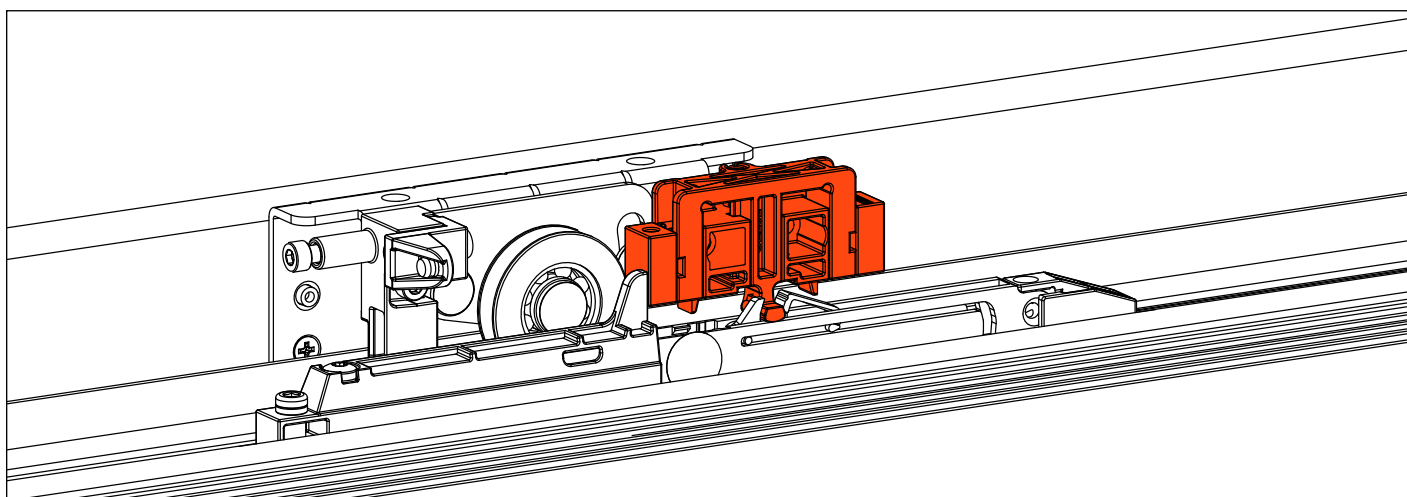

Glow+
Características principais

Inovador amortecedor magnético que garante um movimento fluido e silencioso.

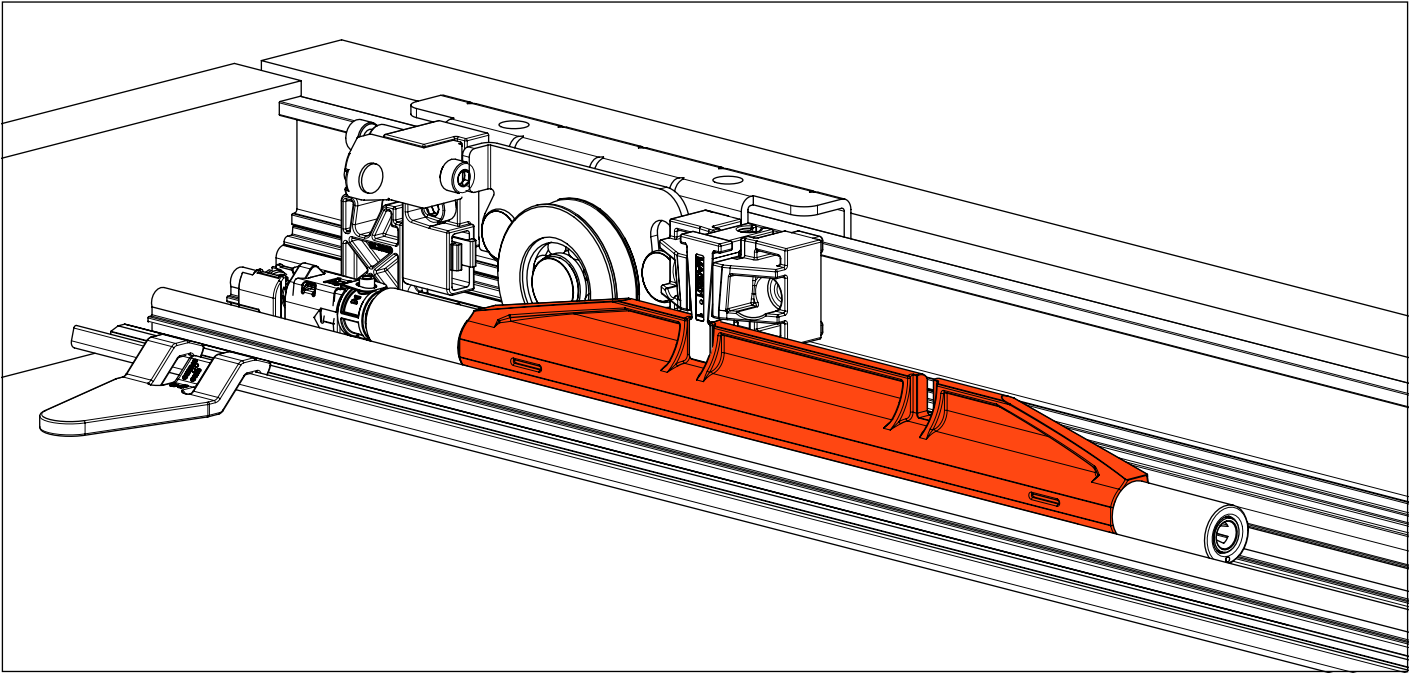

Pino ativador extremamente fácil de montar e reposicionar.

Gancho automático, com rearme, entre o carrinho e o amortecedor.

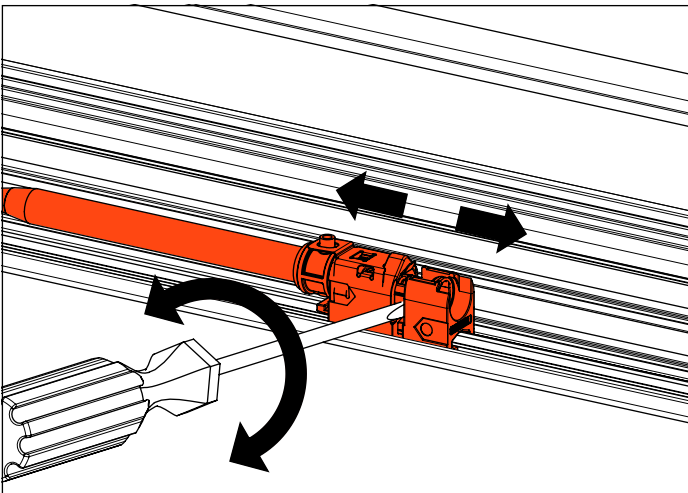

Cobertura frontal do mecanismo com gancho magnético.

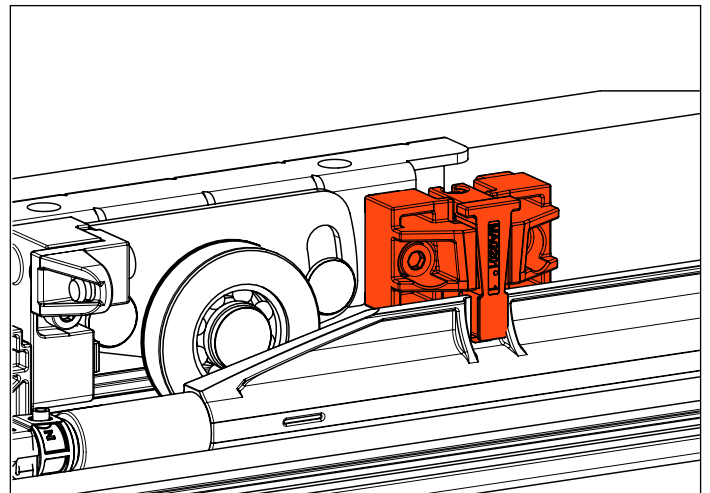

Instalação dos trilhos mediante clip com montagem a pressão.

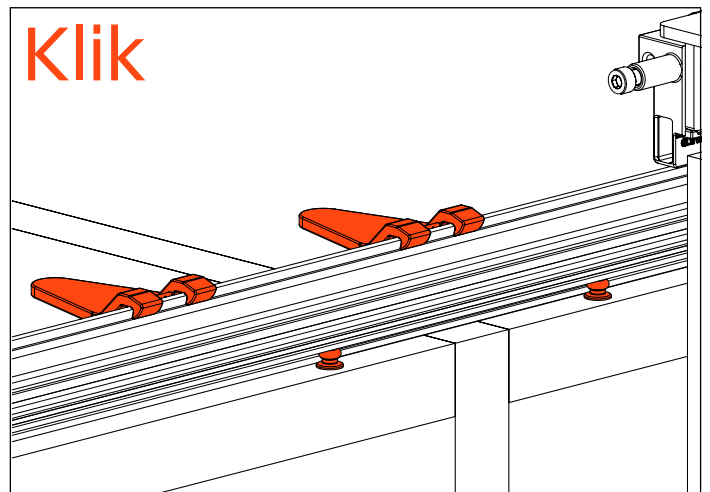
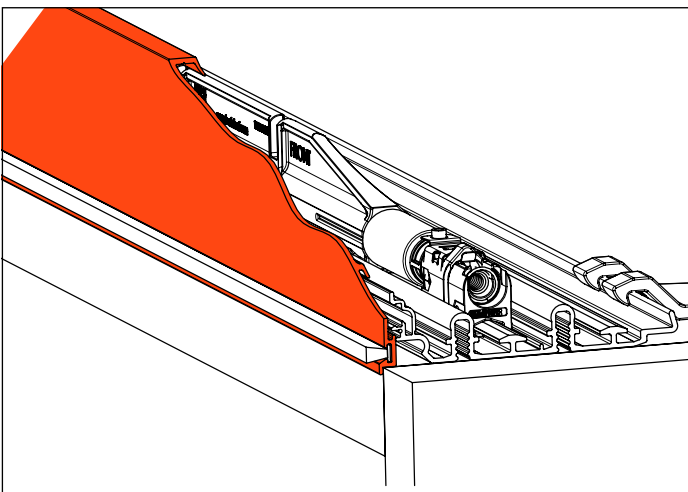



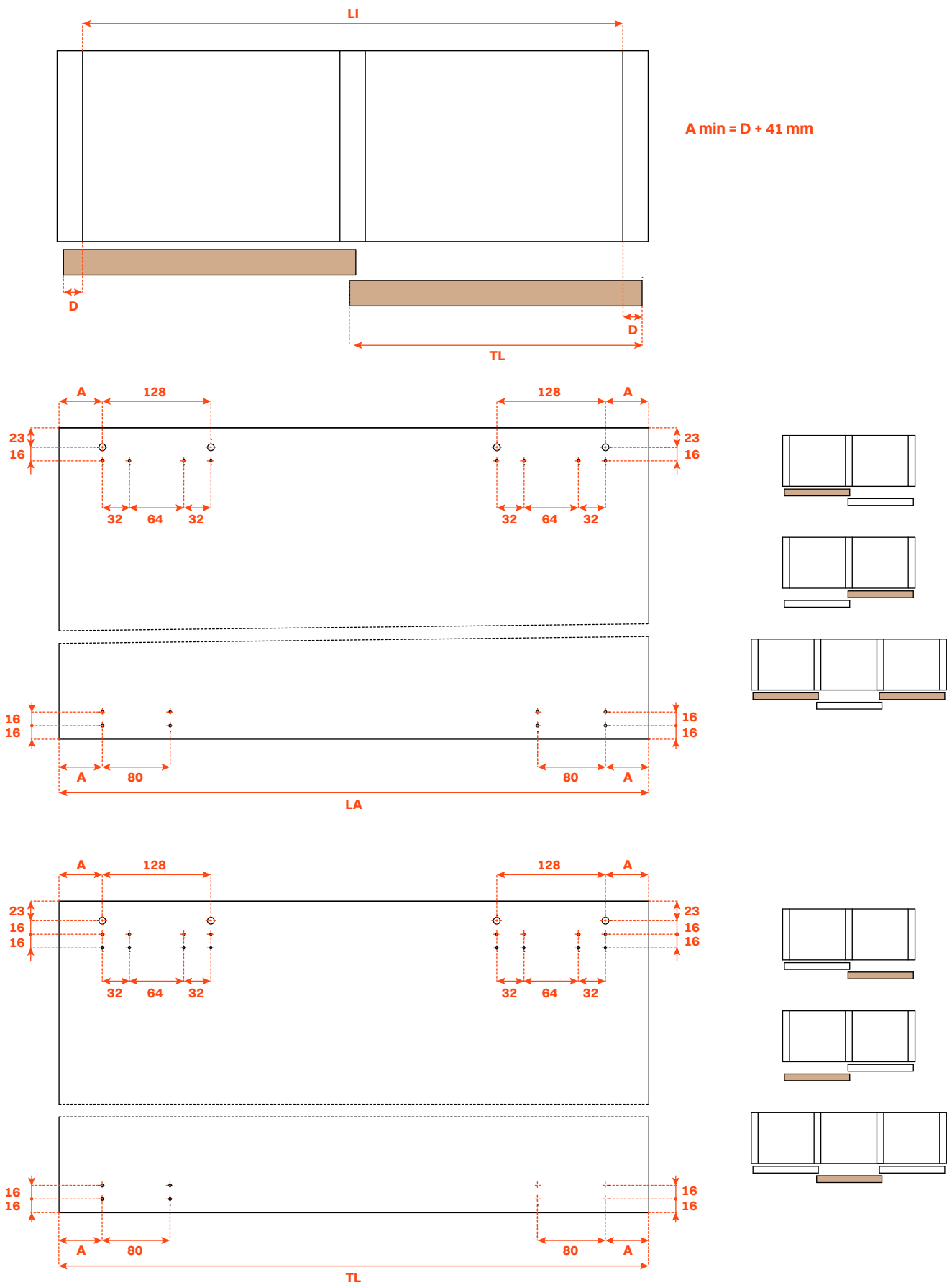



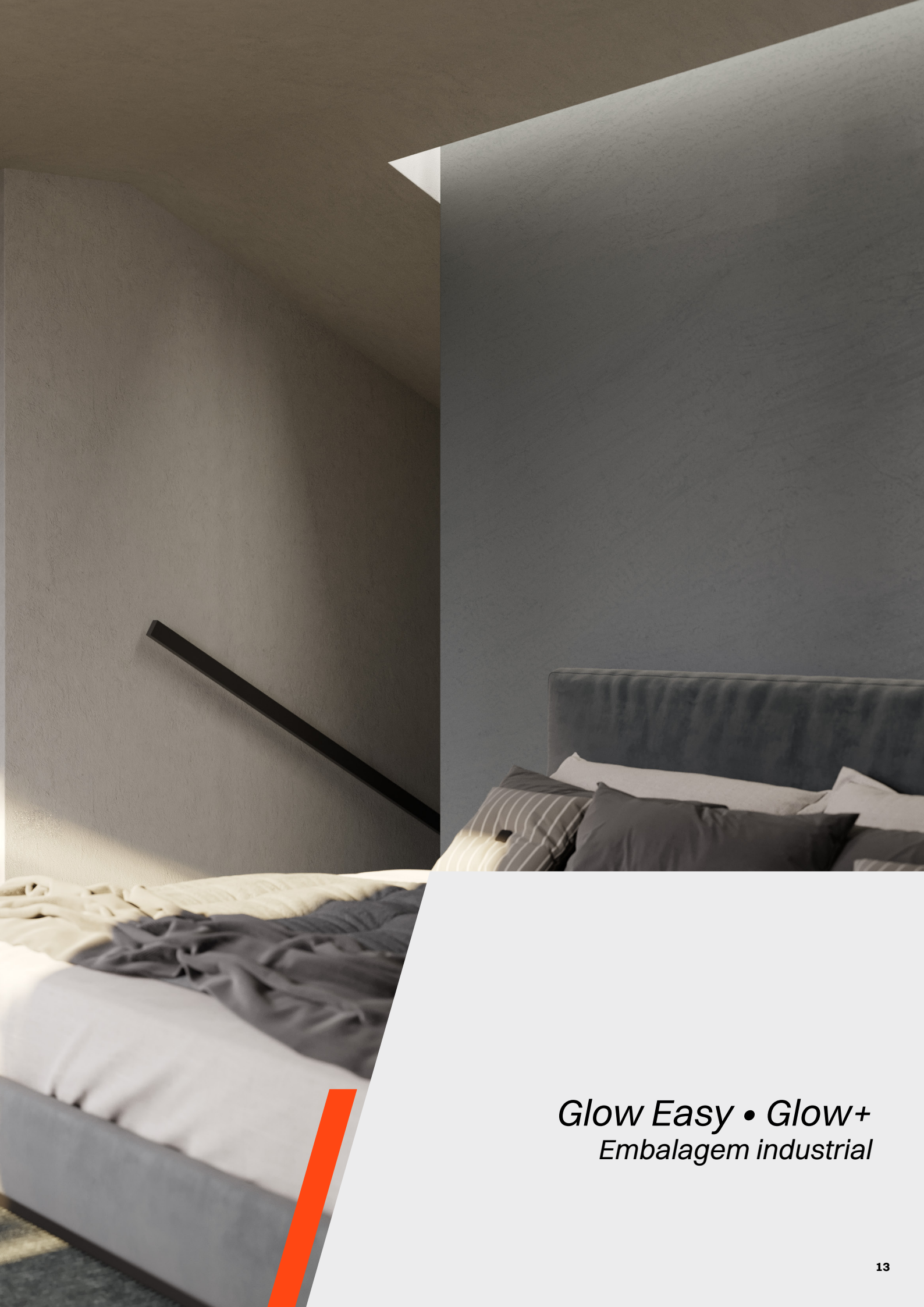

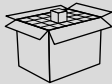

Usinagens na porta







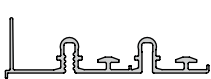



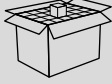

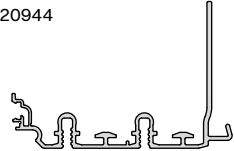

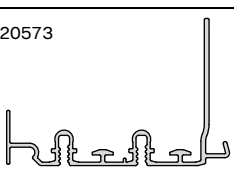

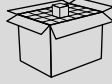
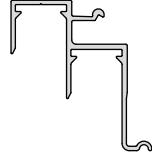

Glow Easy • Glow+
Embalagem industrial

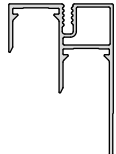
Trilho superior standard	L	Código	 pç.	Fixação	
	mm				
Predisposto para acabamento frontal	6200	VE41PIA16200AB	8	Klik 	21152 
	3100	VE41PTA13100AB	8	Klik 	
Sem predisposição para acabamento frontal	6200	VE41PIB16200AB	8	Klik 	21151 
	3100	VE41PTB13100AB	8	Klik 	
Sem predisposição para acabamento frontal	6200	VE41PIB36200AB	8		300840 
	3100	VE41PTB33100AB	8		

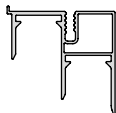

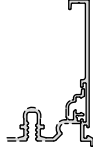
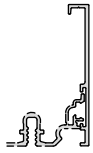
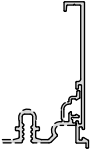

Trilho superior reforçado	L	Código	 pç.	Fixação	
	mm				
Predisposto para acabamento frontal	6200	VE41PIA26200AB	8	Klik 	20944 
	3100	VE41PTA23100AB	8	Klik 	
Sem predisposição para acabamento frontal	6200	VE41PIB26200AB	8	Klik 	20573 
	3100	VE41PTB23100AB	8	Klik 	

Trilho inferior	L	Código	 pç.	Fixação	
	mm				
	6200	VE41BIX06200AB	8	Klik	39428 
	3100	VE41BTX03100AB	8	Klik	
	6200	VE41PIE16200AB	8		21162 
	3100	VE41PTE13100AB	8		
	6200	VE41PIE26200AB	8		300841 
	3100	VE41PTE23100AB	8		



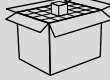









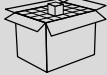

Perfis de cobertura













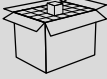

Acabamento frontal	L	Código	 pç.	
	mm			
Com canal para escova, acabamento alumínio	6200	VE41BIA06200AB	8	34032 
	3100	VE41BTA03100AB	8	
Sem canal para escova, acabamento alumínio	6200	VE41BIB06200AB	8	35510 
	3100	VE41BTB03100AB	8	
Com canal para escova, acabamento titânio	6200	VE41BIA06200SB	8	34032 
	3100	VE41BTA03100SB	8	

Carrinhos de deslizamento porta interna



Artigo	 mm	Código	 pç.	
Carrinho superior direito		VE41KMCMi350DX0	30	
Carrinho superior esquerdo		VE41KMCMi350SX0	30	
Carrinho inferior	17	VE41KMGLW310	30	
	33	VE41KMGLW320	30	

Glow Easy • Glow+
Carrinhos de deslizamento porta externa

Artigo	 mm	 mm	Código	 pç.	
Carrinho superior direito	≤ 23		VE41KMCMi370DX0	30	
Carrinho superior esquerdo	≤ 23		VE41KMCMi370SX0	30	
Carrinho inferior	≤ 23	17	VE41KMGLW311	30	
	≤ 23	33	VE41KMGLW321	30	
Carrinho superior direito	≤ 26		VE41KMCMi375DX0	30	
Carrinho superior esquerdo	≤ 26		VE41KMCMi375SX0	30	
Carrinho inferior	≤ 26	17	VE41KMGLW316	30	
	≤ 26	33	VE41KMGLW326	30	
Carrinho superior direito	≤ 30		VE41KMCMi371DX0	30	
Carrinho superior esquerdo	≤ 30		VE41KMCMi371SX0	30	
Carrinho inferior	≤ 30	17	VE41KMGLW312	30	
	≤ 30	33	VE41KMGLW322	30	

Artigo	 mm	 mm	Código	 pç.	
Carrinho superior direito	≤ 35		VE41KMCM1372DX0	30	
Carrinho superior esquerdo	≤ 35		VE41KMCM1372SX0	30	
Carrinho inferior	≤ 35	17	VE41KMGLW313	30	
	≤ 35	33	VE41KMGLW323	30	
Carrinho superior direito	≤ 40		VE41KMCM1374DX0	30	
Carrinho superior esquerdo	≤ 40		VE41KMCM1374SX0	30	
Carrinho inferior	≤ 40	17	VE41KMGLW315	30	
	≤ 40	33	VE41KMGLW325	30	
Carrinho superior direito	≤ 50		VE41KMCM1373DX0	30	
Carrinho superior esquerdo	≤ 50		VE41KMCM1373SX0	30	
Carrinho inferior	≤ 50	17	VE41KMGLW314	30	
	≤ 50	33	VE41KMGLW324	30	

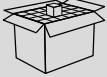
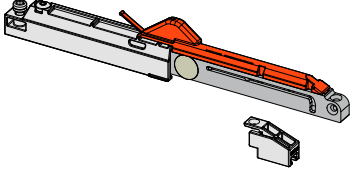
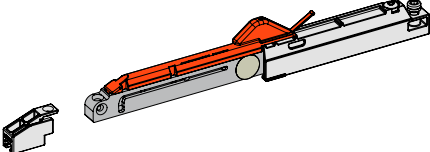
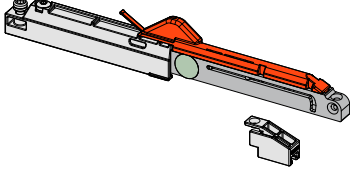
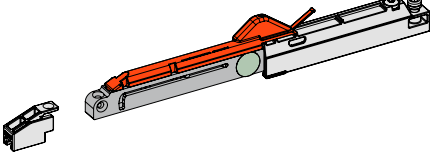
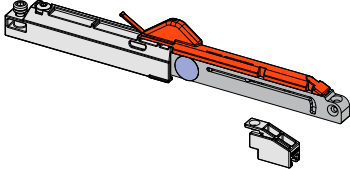
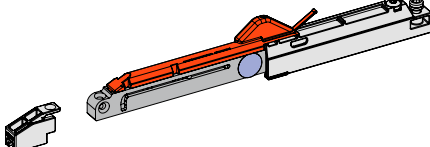
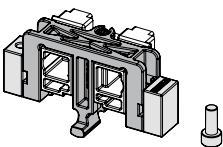

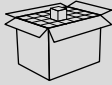
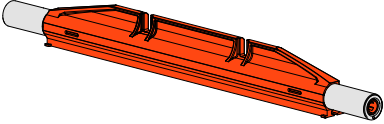
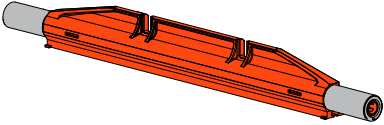
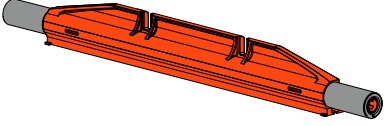
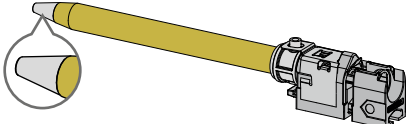
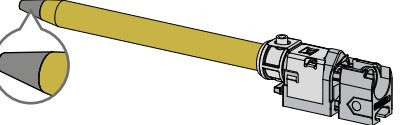
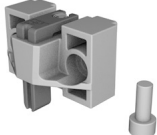
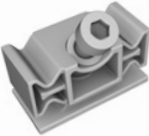

Glow Easy
 Amortecedor e pino ativador

Artigo	Código	 pç	
Amortecedor Easy direito MAX 30 Kg	VE41KGEAMMR02B	30	
Amortecedor Easy esquerdo MAX 30 Kg	VE41KGEAMML03B	30	
Amortecedor Easy direito 30 - 50 Kg	VE41KGEAMMR04B	30	
Amortecedor Easy esquerdo 30 - 50 Kg	VE41KGEAMML05B	30	
Amortecedor Easy direito 50 - 70 Kg	VE41KGEAMMR06B	30	
Amortecedor Easy esquerdo 50 - 70 Kg	VE41KGEAMML07B	30	
Ativador para amortecedor Easy	VE41KGEAMM001B	30	
Batente inferior	VE41KMGLW220	60	









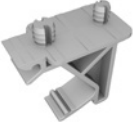

Glow+
 Amortecedor e pino ativador

Artigo	Código	 pç	
Amortecedor magnético Max 25 Kg	VE41KMAMCMA0500	30	
Amortecedor magnético 25 - 45 Kg	VE41KMAMCMA1000	30	
Amortecedor magnético 45 - 70 Kg	VE41KMAMCMA2000	30	
Pino ativador para amortecedor magnético Max 25 e 25 - 45 Kg	VE41KMAMCMA5000	60	
Pino ativador para amortecedor magnético 45 - 70 Kg	VE41KMAMCMA5100	60	
Tracionador para amortecedor magnético	VE41KMAMCMA3000	30	
Batente inferior	VE41KMGLW220	60	

Glow Easy • Glow+
Batentes não amortecidos

Artigo	Código	 pç.	
Parada final	VE41KMANCMI2000	60	
Ativador para parada final	VE41KMANCMI3000	30	
Batente inferior	VE41KMGLW220P	60	









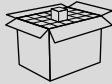

Acessórios





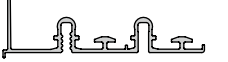

Artigo	Código	 pç.	
Pino Frontal	VE41MPGLW160	180	
Clip superior	VE41MPGLW260	180	
Clip inferior	VE41MPGLW270.0	180	
Aplicador clip inferior	VE41MPGLW271.0	30	
Contra placa	VE41MPGLW330	200	
Imã 25x6	VE41MPMA250603	200	
Escova H7 cinza	VE41MPPB4829	325 m	
Kit ganchos anti-descarrilamento (Direito+Esquerdo)	VE41MPGLW280	30	
Pino anticolisão	VE41KMGLW510	30	
Protetor de puxador	VE41KMGLW230	30	



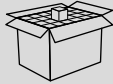

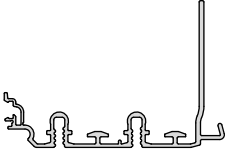

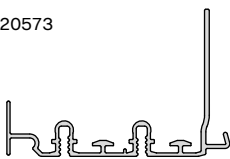



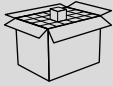

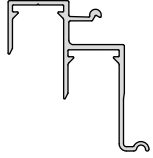
Glow Easy • Glow+
Embalagem do kit

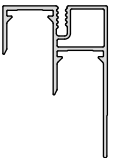

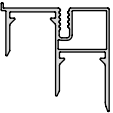

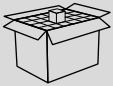
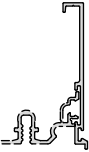
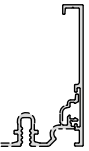
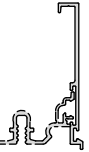

Trilho superior standard	L	Código	 pç.	Fixação	
	mm				
Predisposto para acabamento frontal	6200	VE41PIA16200AB	8	Klik 	21152 
	3100	VE41PTA13100AB	8	Klik 	
Sem predisposição para acabamento frontal	6200	VE41PIB16200AB	8	Klik 	21151 
	3100	VE41PTB13100AB	8	Klik 	
Sem predisposição para acabamento frontal	6200	VE41PIB36200AB	8		300840 
	3100	VE41PTB33100AB	8		

Trilho superior reforçado	L	Código	 pç.	Fixação	
	mm				
Predisposto para acabamento frontal	6200	VE41PIA26200AB	8	Klik 	20944 
	3100	VE41PTA23100AB	8	Klik 	
Sem predisposição para acabamento frontal	6200	VE41PIB26200AB	8	Klik 	20573 
	3100	VE41PTB23100AB	8	Klik 	





Perfil inferior	L	Código	 pç.	Fixação	
	mm				
	6200	VE41BIX06200AB	8	Klik 	39428 
	3100	VE41BTX03100AB	8	Klik 	
	6200	VE41PIE16200AB	8		21162 
	3100	VE41PTE13100AB	8		
	6200	VE41PIE26200AB	8		300841 
	3100	VE41PTE23100AB	8		

Acabamento frontal	L	Código	 pç.		
	mm				
Com canal para escova, acabamento alumínio	6200	VE41BIA06200AB	8		34032 
	3100	VE41BTA03100AB	8		
Sem canal para escova, acabamento alumínio	6200	VE41BIB06200AB	8		35510 
	3100	VE41BTB03100AB	8		
Com canal para escova, acabamento titânio	6200	VE41BIA06200SB	8		34032 
	3100	VE41BTA03100SB	8		





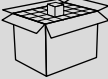

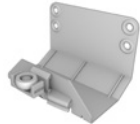

Kit carrinhos para armário com porta individual interna

Artigo	 mm	 mm	Código	 pç.	
Carrinhos internos para armário com porta individual	-	17	VE41KSKSGE1090	1	 x 1
	-	33	VE41KSKSGE1590	1	 x 1  x 2



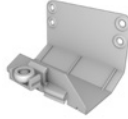





Kit carrinhos para armário com porta individual externa

Artigo	 mm	 mm	Código	 pç.	
Carrinhos externos para armário com porta individual	≤ 23	17	VE41KSKSGE1010	1	 x 1
	≤ 23	33	VE41KSKSGE1510	1	 x 1
	≤ 30	17	VE41KSKSGE1020	1	 x 2
	≤ 30	33	VE41KSKSGE1520	1	

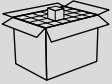

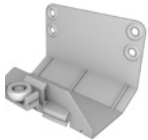







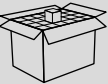
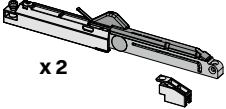

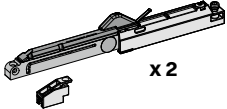

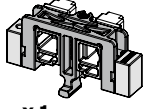

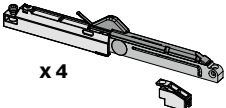

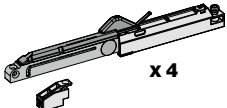

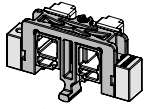

Kit carrinhos para armário de 2 portas

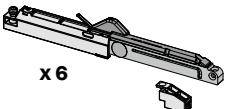
Artigo	 mm	 mm	Código	 pç.	
Carrinhos para armário de 2 portas	≤ 23	17	VE41KSKSGE2010	1	 x 1
	≤ 23	33	VE41KSKSGE2510	1	
	≤ 26	17	VE41KSKSGE2060	1	 x 1
	≤ 26	33	VE41KSKSGE2560	1	
	≤ 30	17	VE41KSKSGE2020	1	 x 2
	≤ 30	33	VE41KSKSGE2520	1	
	≤ 35	17	VE41KSKSGE2030	1	 x 1
	≤ 35	33	VE41KSKSGE2530	1	
	≤ 40	17	VE41KSKSGE2040	1	 x 1
	≤ 40	33	VE41KSKSGE2540	1	
	≤ 50	17	VE41KSKSGE2050	1	 x 2
	≤ 50	33	VE41KSKSGE2550	1	

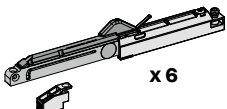

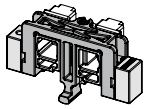







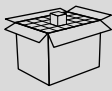







Kit carrinhos para armário de 3 portas

Artigo	 mm	 mm	Código	 pç.	
Carrinhos para armário de 3 portas	≤ 23	17	VE41KSKSGE3010	1	 x 1
	≤ 23	33	VE41KSKSGE3510	1	 x 1
	≤ 26	17	VE41KSKSGE3060	1	 x 2
	≤ 26	33	VE41KSKSGE3560	1	 x 2
	≤ 30	17	VE41KSKSGE3020	1	 x 2
	≤ 30	33	VE41KSKSGE3520	1	 x 4
	≤ 35	17	VE41KSKSGE3030	1	
	≤ 35	33	VE41KSKSGE3530	1	
	≤ 40	17	VE41KSKSGE3040	1	
	≤ 40	33	VE41KSKSGE3540	1	
	≤ 50	17	VE41KSKSGE3050	1	
	≤ 50	33	VE41KSKSGE3550	1	

Glow Easy
Kit de amortecedores a óleo

Artigo	Portas	 Peso da porta	Código	 pç.	
Amortecedores para armário de 1, 2 ou 3 portas	1	Max 30 Kg	VE41KSAMGE1010	1	 x 2 
	1	30 - 50 Kg	VE41KSAMGE1020	1	 x 2 
	1	50 - 70 Kg	VE41KSAMGE1030	1	 x 1  x 1  x 2
	2	Max 30 Kg	VE41KSAMGE2010	1	 x 4 
	2	30 - 50 Kg	VE41KSAMGE2020	1	 x 4 
	2	50 - 70 Kg	VE41KSAMGE2030	1	 x 2  x 3  x 1  x 4
	3	Max 30 Kg	VE41KSAMGE3010	1	 x 6 
	3	30 - 50 Kg	VE41KSAMGE3020	1	 x 6 
	3	50 - 70 Kg	VE41KSAMGE3030	1	 x 3  x 4  x 1  x 4

Glow+
Kit de amortecedores magnéticos

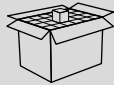
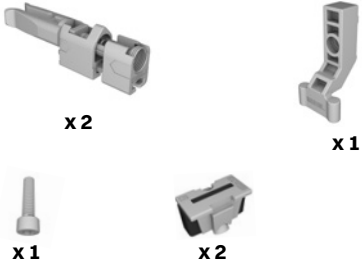
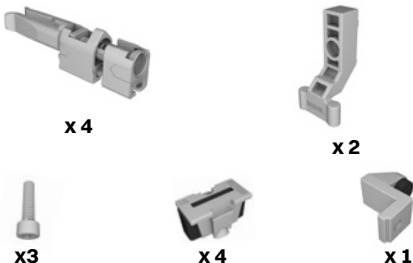
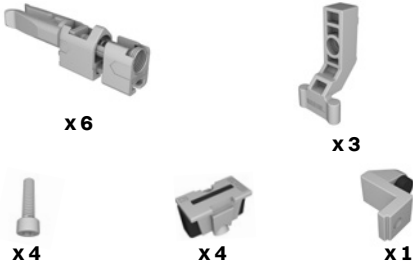

Artigo	Porta	 Peso da porta	Código	 pç.	
Amortecedores para armário de 1, 2 ou 3 portas	1	Max 25 Kg	VE41KSAMGP4010	1	 x 1
	1	25 - 45 Kg	VE41KSAMGP4020	1	 x 2
	1	45 - 70 Kg	VE41KSAMGP4030	1	 x 2  x 1  x 1
	2	Max 25 Kg	VE41KSAMGP5010	1	 x 2
	2	25 - 45 Kg	VE41KSAMGP5020	1	 x 4  x 4
	2	45 - 70 Kg	VE41KSAMGP5030	1	 x 3  x 2  x 1
	3	Max 25 Kg	VE41KSAMGP6010	1	 x 3
	3	25 - 45 Kg	VE41KSAMGP6020	1	 x 6  x 4
	3	45 - 70 Kg	VE41KSAMGP6030	1	 x 4  x 3  x 1

Glow Easy • Glow+
 Kit não amortecido

Artigo	Porta	Código	 pç.	
Batentes para armário de 1, 2 ou 3 portas	1	VE41KSNAGE7000	1	 <p>x 2 x 1</p> <p>x 1 x 2</p>
	2	VE41KSNAGE8000	1	 <p>x 4 x 2</p> <p>x 3 x 4 x 1</p>
	3	VE41KSNAGE9000	1	 <p>x 6 x 3</p> <p>x 4 x 4 x 1</p>

Glow Easy • Glow

Kit carrinhos 100 kg • Par de carrinhos, que unidos aos carrinhos standard, aumenta a capacidade de carga para porta até no máximo 100 kg.

Artigo	Código	 pç.	
Carrinhos para porta interna	VE41KSKPCMI1A99	1	 x1 x1

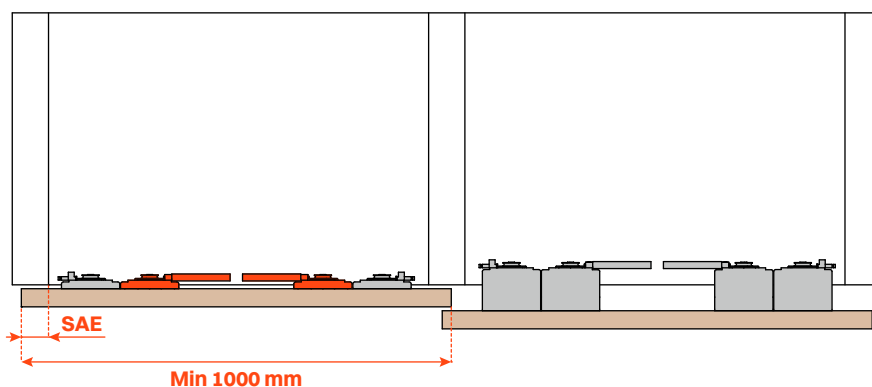
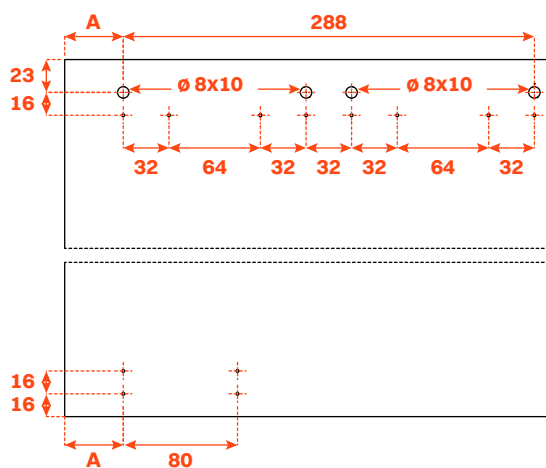

A min = SAE + 41 mm

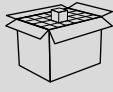
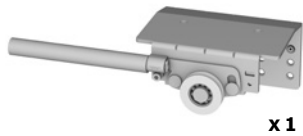
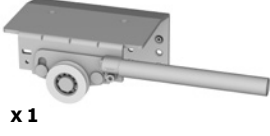

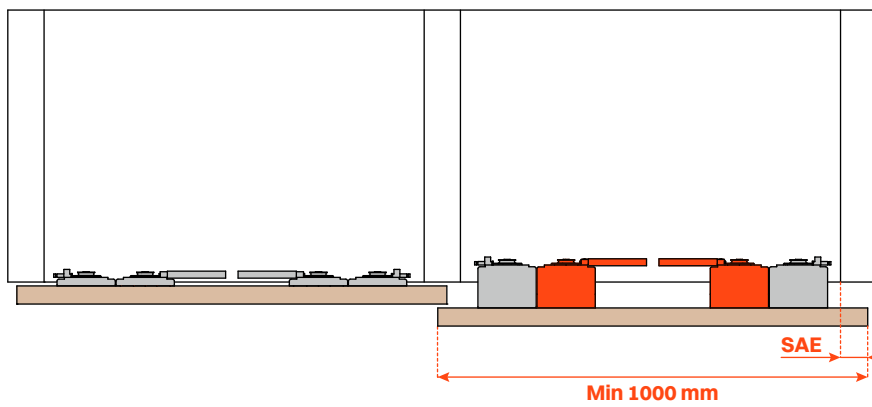
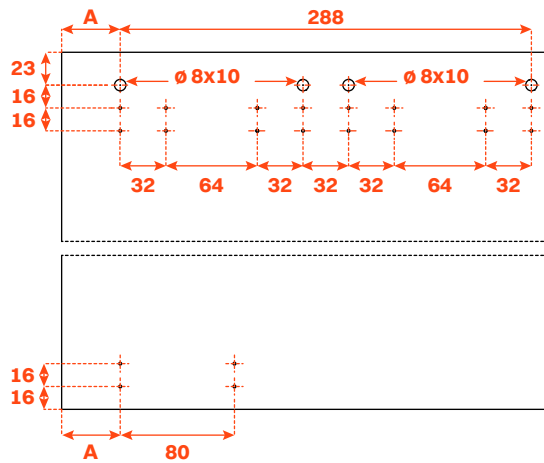

Artigo	 mm	Código	 pç.	
Carrinhos para porta externa	23	VE41KSKPCMI1A19	1	 x 1  x 1
	26	VE41KSKPCMI1A69	1	
	30	VE41KSKPCMI1A29	1	
	35	VE41KSKPCMI1A39	1	
	40	VE41KSKPCMI1A49	1	
	50	VE41KSKPCMI1A59	1	





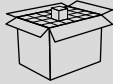



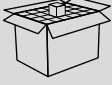

A min = SAE + 41 mm

Glow Easy • Glow+

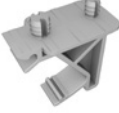
Kit de acessórios para acabamento frontal

Artigo	L	Código	 pç.	
	mm			
Kit imãs, contra placas e escova	≤ 2000	VE41KSM0S05	1	
	≤ 3000	VE41KSM0S06	1	
	≤ 4000	VE41KSM0S07	1	

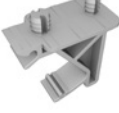
Kit clip

Artigo	Código	 pç.				
Kit 6 clips com aplicador	VE41KSCLIP6	1	 x 6	 x 6	 x 6	 x 1
Kit 9 clips com aplicador	VE41KSCLIP9	1	 x 9	 x 9	 x 9	 x 1

Klik

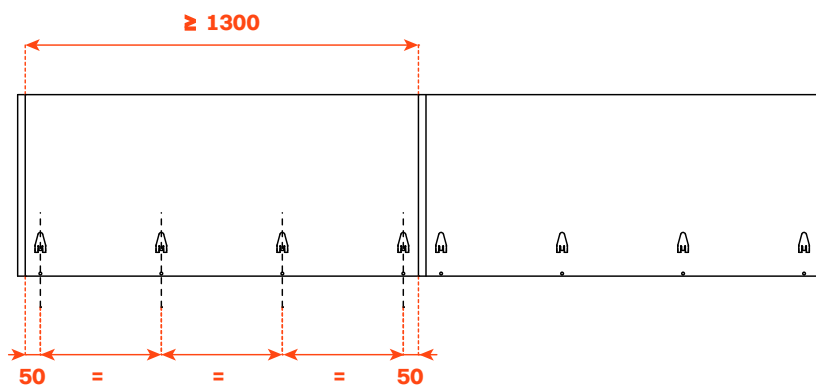
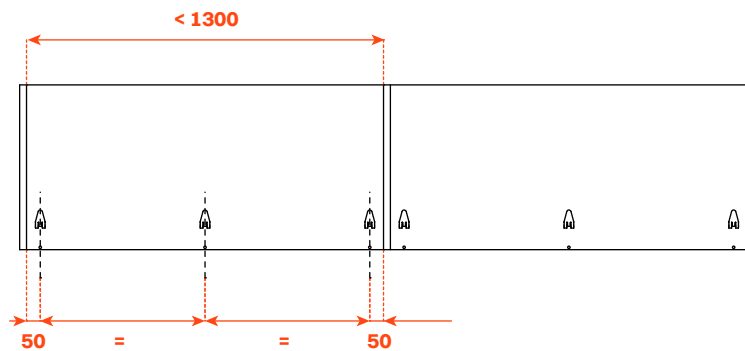

Glow Easy • Glow+

Kit pino anticolisão • Para os armários com 3 portas, é possível pedir os pinos anticolisão para aplicar nas portas internas (1 kit com 2 peças).

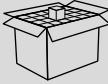
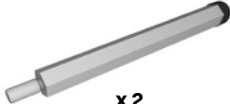
Artigo	Código	 pç.	
Pinos anticolisão	VE41KMGLW510C	1	 x 2

Capa anti-pó com velcro autoadesivo

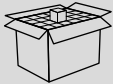
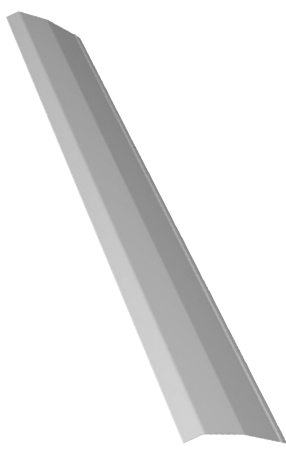
Artigo	L	Código Acabamento preto	Código Acabamento cinza	 pç.	
	mm				
Capa cobre carrinho porta externa	600	VE41CP0A001N3A	VE41CP0A001N6A	1	
	700	VE41CP0A002N3A	VE41CP0A002N6A		
	800	VE41CP0A003N3A	VE41CP0A003N6A		
	900	VE41CP0A004N3A	VE41CP0A004N6A		
	1000	VE41CP0A005N3A	VE41CP0A005N6A		
	1100	VE41CP0A006N3A	VE41CP0A006N6A		
	1200	VE41CP0A007N3A	VE41CP0A007N6A		
	1300	VE41CP0A008N3A	VE41CP0A008N6A		
	1400	VE41CP0A009N3A	VE41CP0A009N6A		
	1500	VE41CP0A010N3A	VE41CP0A010N6A		
	1600	VE41CP0A011N3A	VE41CP0A011N6A		
	1700	VE41CP0A012N3A	VE41CP0A012N6A		
	1800	VE41CP0A013N3A	VE41CP0A013N6A		
	1900	VE41CP0A014N3A	VE41CP0A014N6A		
	2000	VE41CP0A015N3A	VE41CP0A015N6A		
	600	VE41CP0A001N6A	VE41CP0A001N6B	10	
	700	VE41CP0A002N6A	VE41CP0A002N6B		
	800	VE41CP0A003N6A	VE41CP0A003N6B		
	900	VE41CP0A004N6A	VE41CP0A004N6B		
	1000	VE41CP0A005N6A	VE41CP0A005N6B		
	1100	VE41CP0A006N6A	VE41CP0A006N6B		
	1200	VE41CP0A007N6A	VE41CP0A007N6B		
	1300	VE41CP0A008N6A	VE41CP0A008N6B		
	1400	VE41CP0A009N6A	VE41CP0A009N6B		
	1500	VE41CP0A010N6A	VE41CP0A010N6B		
	1600	VE41CP0A011N6A	VE41CP0A011N6B		
	1700	VE41CP0A012N6A	VE41CP0A012N6B		
	1800	VE41CP0A013N6A	VE41CP0A013N6B		
	1900	VE41CP0A014N6A	VE41CP0A014N6B		
	2000	VE41CP0A015N6A	VE41CP0A015N6B		

SEDES E UNIDADES PRODUTIVAS

ARTURO SALICE S.p.A.

SEDE PRINCIPAL

VIA PROVINCIALE NOVEDRATESE, 10
22060 NOVEDRATE (COMO) ITALIA
TEL. 031 790424 - FAX 031 791508
info.salice@salice.com
www.salice.com

ARTURO SALICE S.p.A.

VIA ARISTIDE MERLONI, 11
61036 COLLI AL METAURO (PU) ITALIA
TEL. 0721 899800
FAX 0721 897980
info.salice@salice.com
www.salice.com

BORTOLUZZI SISTEMI S.p.A.

VIA CADUTI 14 SETTEMBRE 1944, 45
32100 BELLUNO (BL) ITALIA
TEL. 0437 930866
FAX 0437 931442
info@bortoluzzi.com
www.salice.com

NUOVA ATIM S.r.l.

VIA IV NOVEMBRE, 52
20019 SETTIMO MILANESE (MI) ITALIA
TEL. 02 33503203
FAX 02 33516514
info@atimspa.com
www.atimspa.com

VILLES S.r.l.

VIA CASTOLDI, 6/8
20090 TREZZANO SUL NAVIGLIO (MI) ITALIA
TEL. 02 4452083
FAX 02 4452838
info@villes2000.com
www.villes2000.com

FILIAIS

DEUTSCHE SALICE GMBH

RUDOLF DIESEL STR. 10
74382 NECKARWESTHEIM
TEL. 07133 9807-0
FAX. 07133 9807-16
info.salice@deutschesalice.de
www.salice.com

DEUTSCHE SALICE GMBH

VERKAUFSBÜRO NORD
RINGSTRASSE 36/A30 CENTER
32584 LÖHNE
TEL. 05731 15608-0
FAX. 05731 15608-10
vknord@deutschesalice.de
www.salice.com

SALICE UK LTD.

KINGFISHER WAY
HINCHINGBROOKE BUSINESS PARK
HUNTINGDON CAMBS PE 29 6FN
TEL. 01480 413831
FAX. 01480 451489
info.salice@saliceuk.co.uk
www.salice.com

SALICE FRANCE S.A.R.L.

285 RUE DE GOA ZAC LES 3 MOULINS
06600 ANTIBES
TEL. 0493 330069
FAX. 0493 330141
info.salice@salicefrance.com
www.salice.com

SALICE ESPAÑA, S.L.U.

C/ AIGUAFREDA 4, P.I. AMETLLA PARK
08480 L'AMETLLA DEL VALLÈS (BARCELONA)
TEL. 0034 938 46 88 61
info.salice@saliceespana.es
www.salice.com

SALICE PORTUGAL UNIP. LDA

SHOWROOM:
TV SÁ E MELO 161 FA
4470-116 MAIA - PORTO
TEL: 00351 224 154 221
Info@saliceportugal.pt
www.salice.com

ARMAZÉM:
VIA ROTA DOS MÓVEIS I 399
4585-325 GANDRA

SALICE CHINA (SHANGHAI) CO. LTD.

RM 602, 6/F, TOWER 1,
3688 YINGGANG DONG ROAD
QINGPU DISTRICT
201703 SHANGHAI, CHINA
TEL. 021 3988-9880
info.salice@salicechina.com
www.salicechina.com

SALICE INDIA PVT. LTD.

1001 & 1002, 10TH FLOOR,
CENTRUM, PLOT NO. C-3,
OPP. WAGLE PRABHAG SAMITI OFFICE,
MIDC AREA, WAGLE INDUSTRIAL ESTATE,
THANE - 400604, MAHARASHTRA
TEL. 022 20812050
info@saliceindia.com
www.salice.com

SALICE CANADA INC.

3500 RIDGEWAY DRIVE,
UNIT#1
MISSISSAUGA, ONTARIO, L5L 0B4
TEL. 905 820 8787
FAX. 905 820 7226
info.salice@salicecanada.com
www.salicecanada.com

SALICE AMERICA INC.

2123 CROWN CENTRE DRIVE
CHARLOTTE NC. 28227
TEL. 704 841 7810
FAX. 704 841 7808
info.salice@saliceamerica.com
www.saliceamerica.com

ARTURO SALICE S.p.A.

SEDE PRINCIPAL

VIA PROVINCIALE NOVEDRATESE, 10
22060 NOVEDRATE (COMO) ITALIA
TEL. 031 790424 - FAX 031 791508

info.salice@salice.com
www.salice.com



Conteúdo digital

Reservamo-nos o direito de modificar as especificações técnicas.



DOCASS004POR Ed. 05 - 05/2026