







## Componentes eléctricos para estante modular

### Alimentadores

	Código	Descripción	
1	VE80EAMA101XXA	Alimentador 120/240 24V 90W 8U. + cable UE (1/1)	
	VE80EAMA102XXA	Alimentador 120/240 24V 90W 8U. + cable UK (1/1)	
	VE80EAMA103XXA	Alimentador 120/240 24V 90W 8U. + cable US (1/1)	
	VE80EAMA104XXA	Alimentador 120/240 24V 90W 8U. + cable CN (1/1)	

	Código	Descripción	
4	VE80EAMA121XXA	Alimentador EDC 120/240 24V 90W 8U. + cable UE (1/1)	
	VE80EAMA122XXA	Alimentador EDC 120/240 24V 90W 8U. + cable UK (1/1)	
	VE80EAMA123XXA	Alimentador EDC 120/240 24V 90W 8U. + cable US (1/1)	
	VE80EAMA124XXA	Alimentador EDC 120/240 24V 90W 8U. + cable CN (1/1)	

### Radio comandos

	Código	Descripción	
9	VE80EBXA001XXA	Radio comando de pared con función dimmer para la intensidad y el tono de la luz Transforma los pulsadores estándar en controller wireless	
5	VE80EBXA102XXA	Radio comando con función dimmer para la intensidad y el tono de la luz.	
6	VE80EBXA003XXA	Radio comando táctil empotrado con función dimmer para la intensidad y el tono de la luz.	
7	VE80EBXA104XXA	Radio comando táctil y PIR (Passive Infrared) con función dimmer para la intensidad y el tono de la luz.	



Función EDC (Emotion Dual Color): el tono de luz varía de cálida a neutra



Función dimmer



Radio: 15 m en el interior del espacio del hogar



Tipo de batería: CR2450





Duración estimada de la batería: 3 años





\* Compatible con alimentador con receptor radiocontrol

	Código	Sensor de movimiento (IR) empotrado para una sola puerta	
11	VE80EBMA123XXA	IR DOOR TUBE - Blanco - 1 puerta	
	VE80EBMA124XXA	IR DOOR TUBE - Negro - 1 puerta	

	Código	Sensor de movimiento (IR) empotrado para puerta doble	
12	VE80EBMA125XXA	IR DOOR TUBE - Blanco - 2 puertas*	 * x2
	VE80EBMA126XXA	IR DOOR TUBE - Negro - 2 puertas*	

	Código	Sensor de proximidad (PIR) empotrado	
13	VE80EBMA121XXA	Sensor de presencia PIR sobre cable de 2 metros de longitud. Mono 24 V DC 4 Máx 5 A total, máx 3 A/output	

	Código	Sensor de proximidad (IR) de montaje empotrado	
14	VE80EBMA122XXA	Sensor a infrared IR sobre cable de 2 metros de longitud. Mono 24 V DC 4 Máx 5 A total, máx 3 A/output	

	Código	Módulo con cable para sensores IR y PIR	
10	VE80EMA101XXA	Módulo con cable para sensores de proximidad y movimiento. Un módulo es controlado por un sensor y tiene 4 salidas	

# Componentes eléctricos para estante modular

## Ejemplos de aplicaciones

### Activación con interruptor de la casa

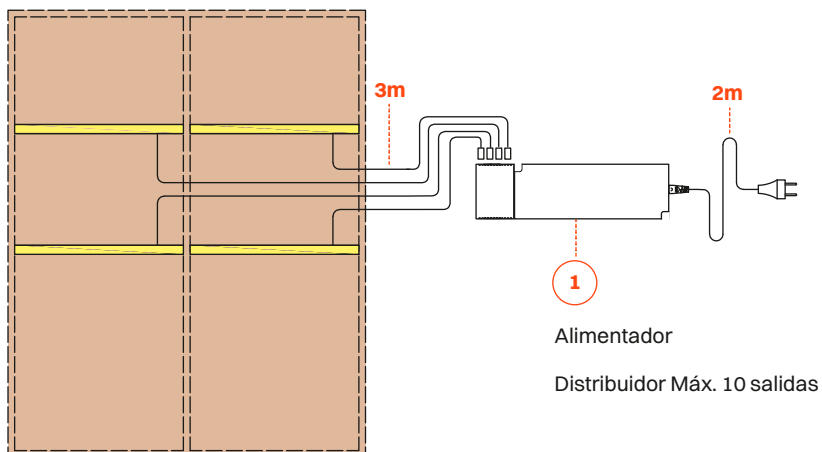

### Activación con controller smart switch

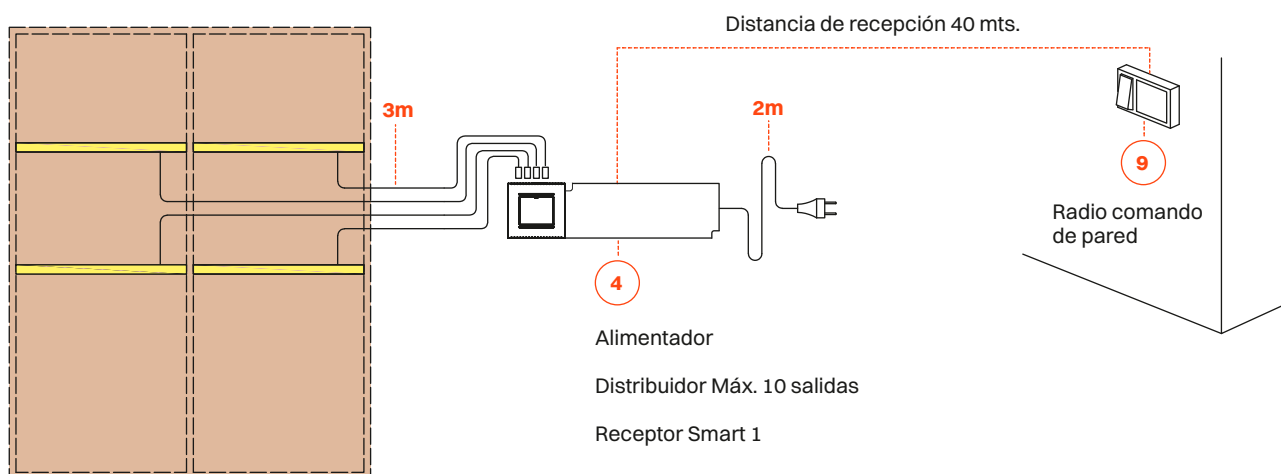

**Activación con 1 o 2 sensores IR - Externos / Empotrados**

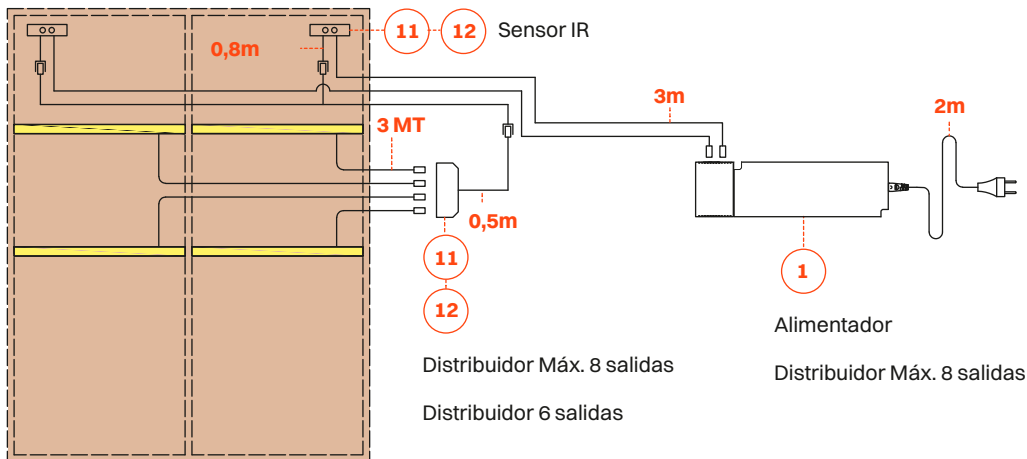

**Activación con controller smart 1**

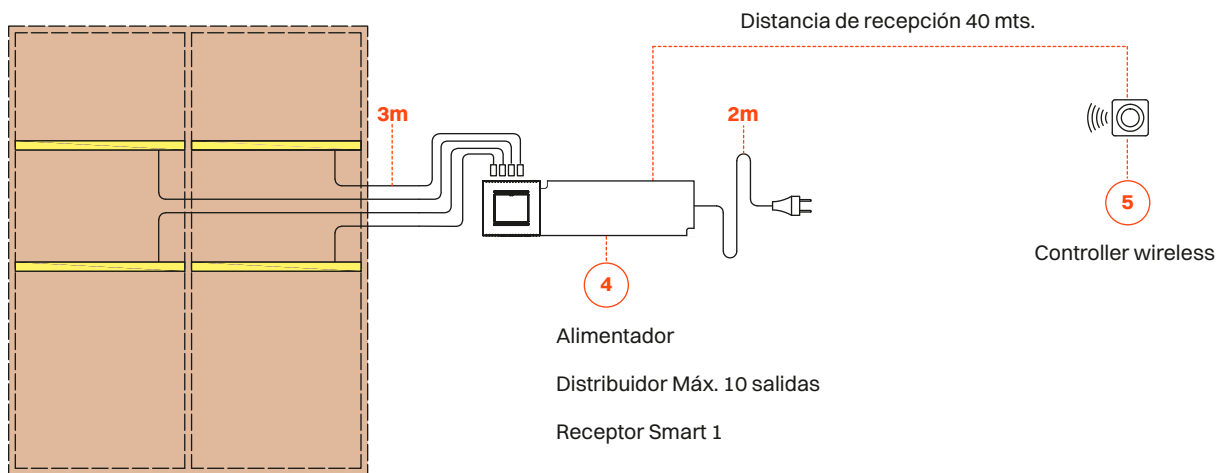

# Componentes eléctricos para estante modular

## Ejemplos de aplicaciones

### Activación con controller smart touch o smart sensor

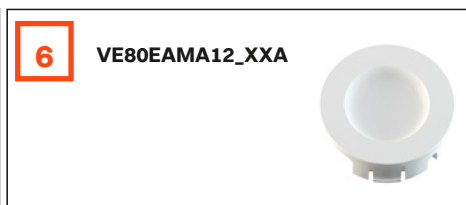
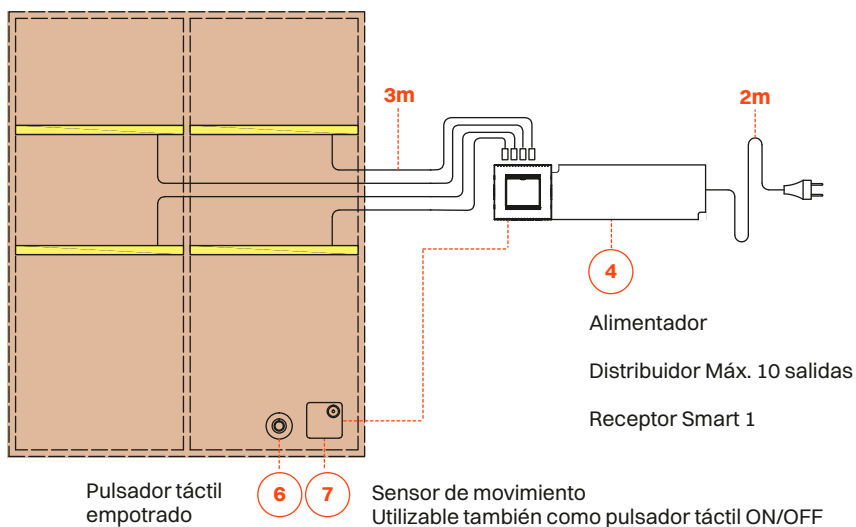

### Activación con controller smart 1 PIR

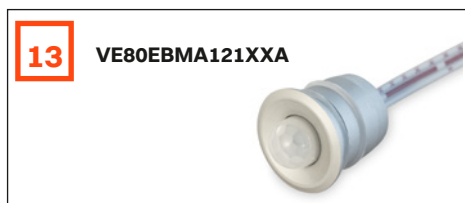
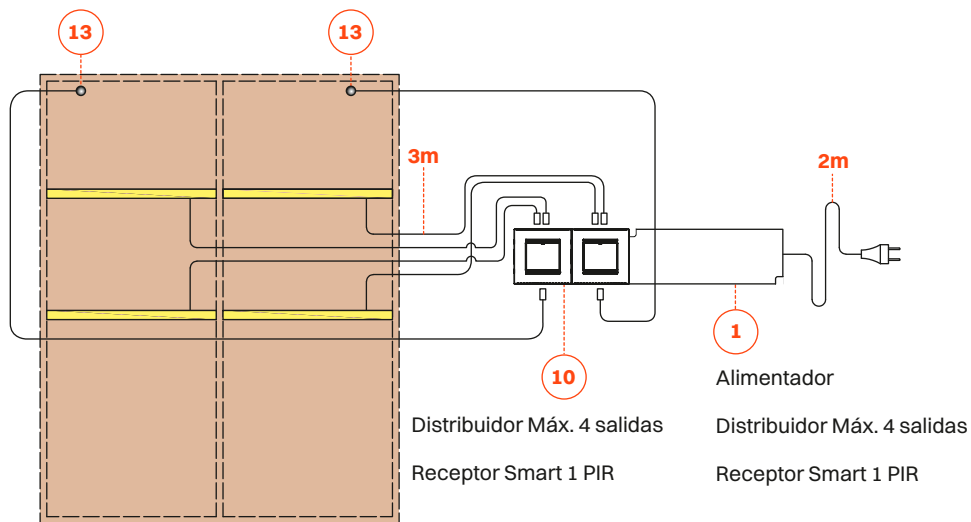

Activación con controller smart 1 IR

