

Accessories

Accessoires

Accessories Accessoires

Stabilizer device for drawers

- To be fitted on both right and left sides of the drawer
- Cam adjustment to allow a perfect fit of the wheels to the cabinet sides
- It makes the function of the Push runners easier no matter where you push the drawer to open
- It improves the overall stability of the drawer by limiting side-to-side racking

Stabilisateur pour tiroirs

- A monter soit sur le côté droit, soit sur le côté gauche du tiroir
- Le réglage par excentrique permet un positionnement parfait des galets sur le côté du meuble
- Il facilite la fonction des coulisses Push, peu importe où vous poussez le tiroir pour l'ouvrir
- Améliore la stabilité générale du tiroir



SINGLE PACKAGING

A686940000202

PACKAGING

1 BOX = 50 ENVELOPES

1 ENVELOPE:

- 2 pcs
- 1 template with assembly instructions

INDUSTRIAL PACKAGING

A686940000200

PACKAGING

1 BOX:

- 300 pcs
- 1 template with assembly instructions



EMBALLAGE INDIVIDUEL

A686940000202

EMBALLAGE

1 CARTON = 50 SACHETS

1 SACHET:

- 2 pièces
- 1 gabarit avec instructions de montage

EMBALLAGE INDUSTRIEL

A686940000200

EMBALLAGE

1 CARTON:

- 300 pièces
- 1 gabarit avec instructions de montage

Template with assembly instructions

Included in the packaging

Gabarit avec instructions de montage

Inclus dans l'emballage

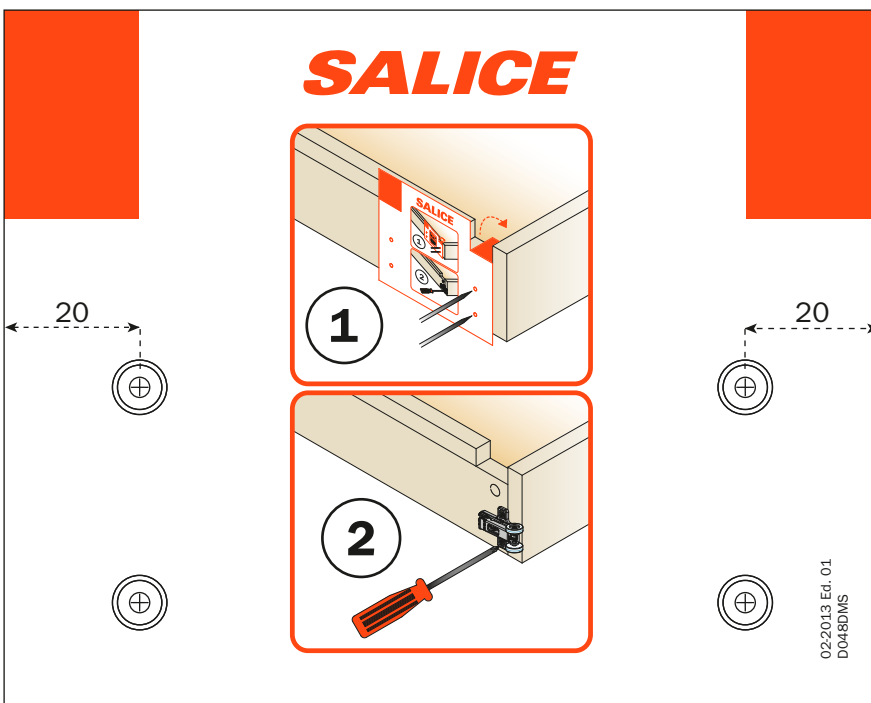

Drawer box drilling templates for Futura runners Gabarits pour le perçage des tiroirs avec coulisses Futura

Clip A710.610

A199800755009

Template for drawer drilling and 1 way adjustable clip fixing

Gabarit pour les perçages des tiroirs et pour le montage du clip à 1 réglage

PACKAGING

1 BOX = 50 pcs

EMBALLAGE

1 carton = 50 pièces

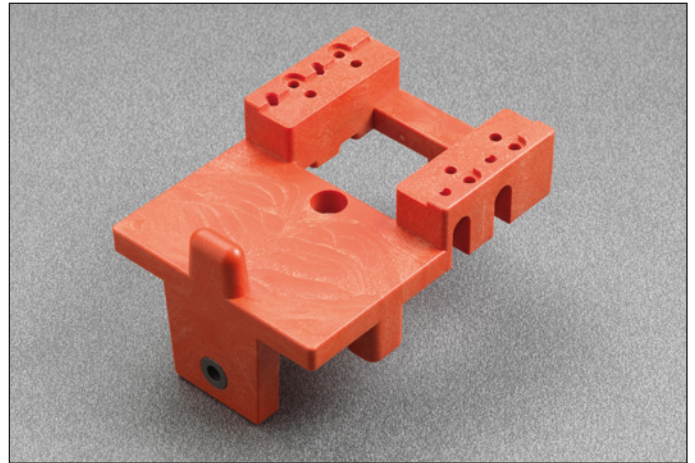
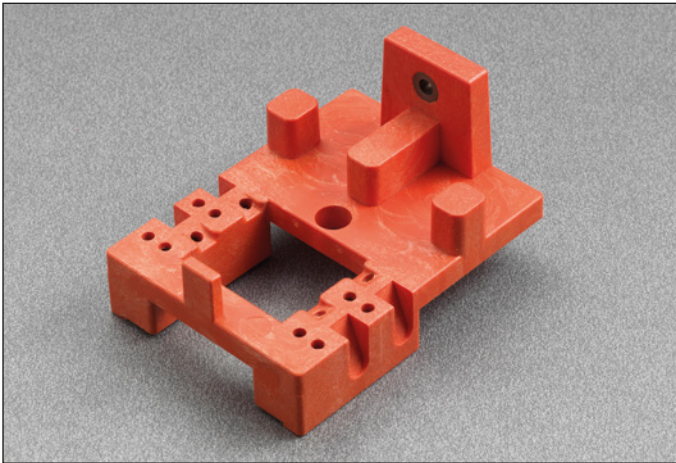
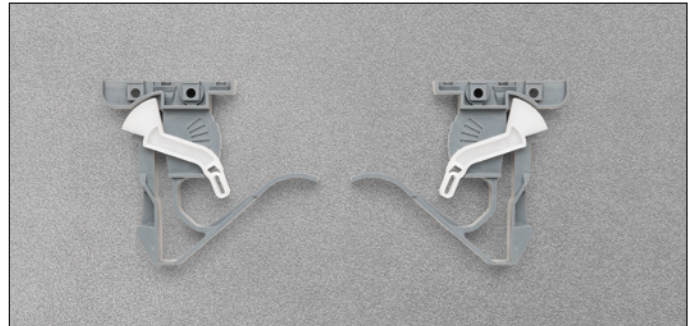

Clip A750.010

A199800755010

Template for drawer drilling and 6 way adjustable clip fixing

Gabarit pour les perçages des tiroirs et pour le montage du clip à 6 réglages

PACKAGING

1 BOX = 50 pcs

EMBALLAGE

1 carton = 50 pièces

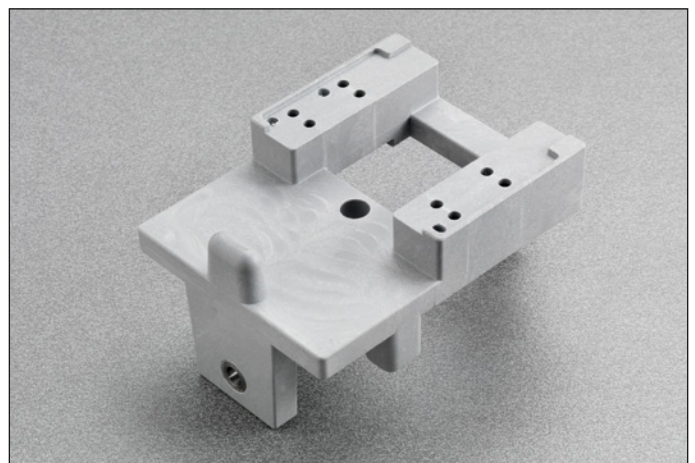
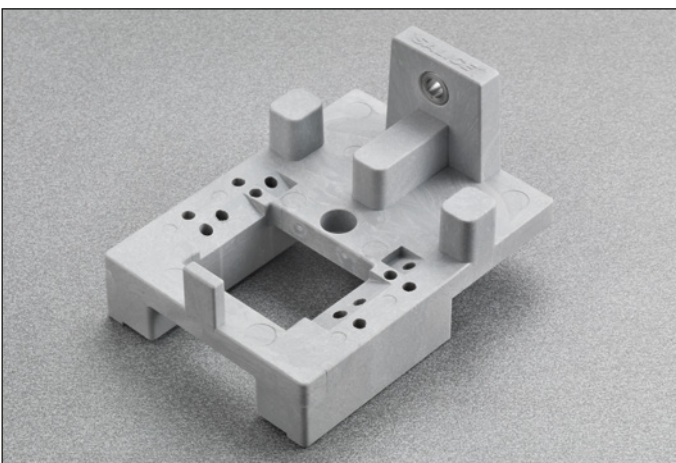
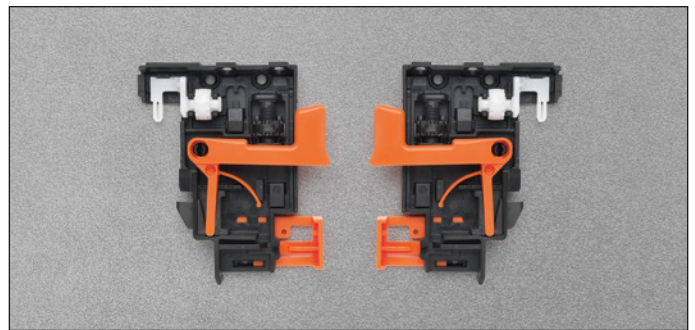

Spacer for Futura runners
Cales d'épaisseur pour coulisses Futura

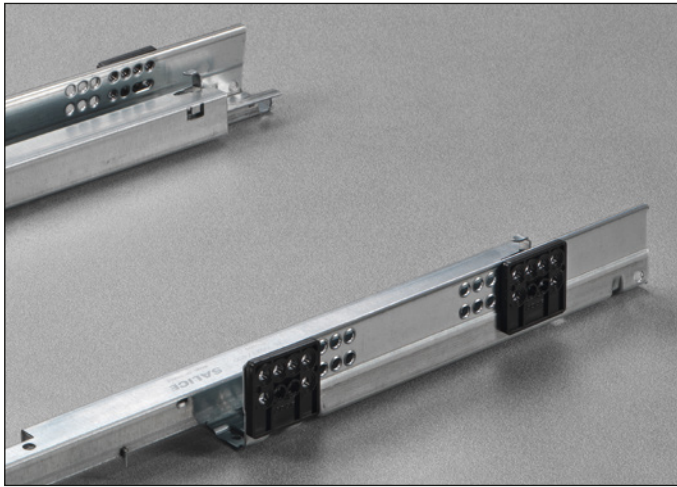

A825104145

Spacer. 4,5 mm thickness

PACKAGING
 1 box = 1000 pcs

Calle d'épaisseur de 4,5 mm

EMBALLAGE
 1 carton = 1000 pièces

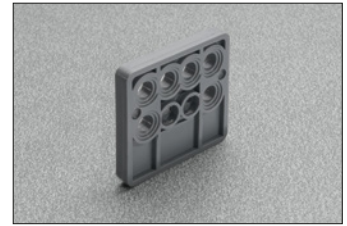

A825104160

Spacer. 6 mm thickness

PACKAGING
 1 box = 800 pcs

Calle d'épaisseur de 6 mm

EMBALLAGE
 1 carton = 800 pièces

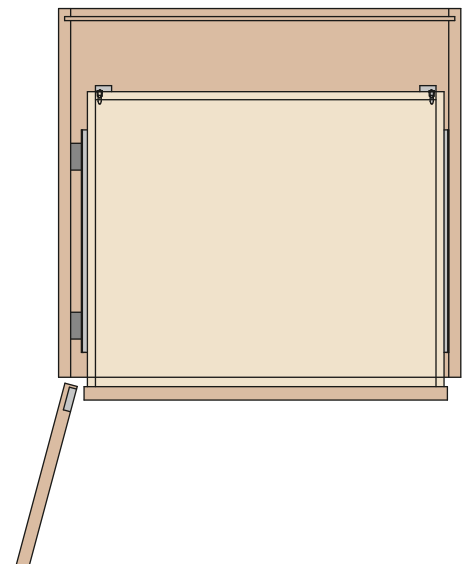
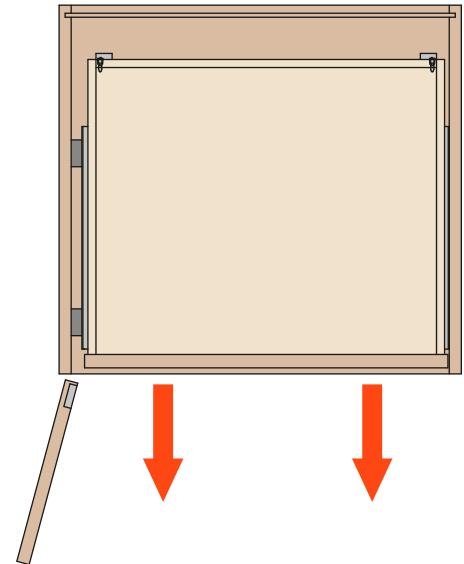
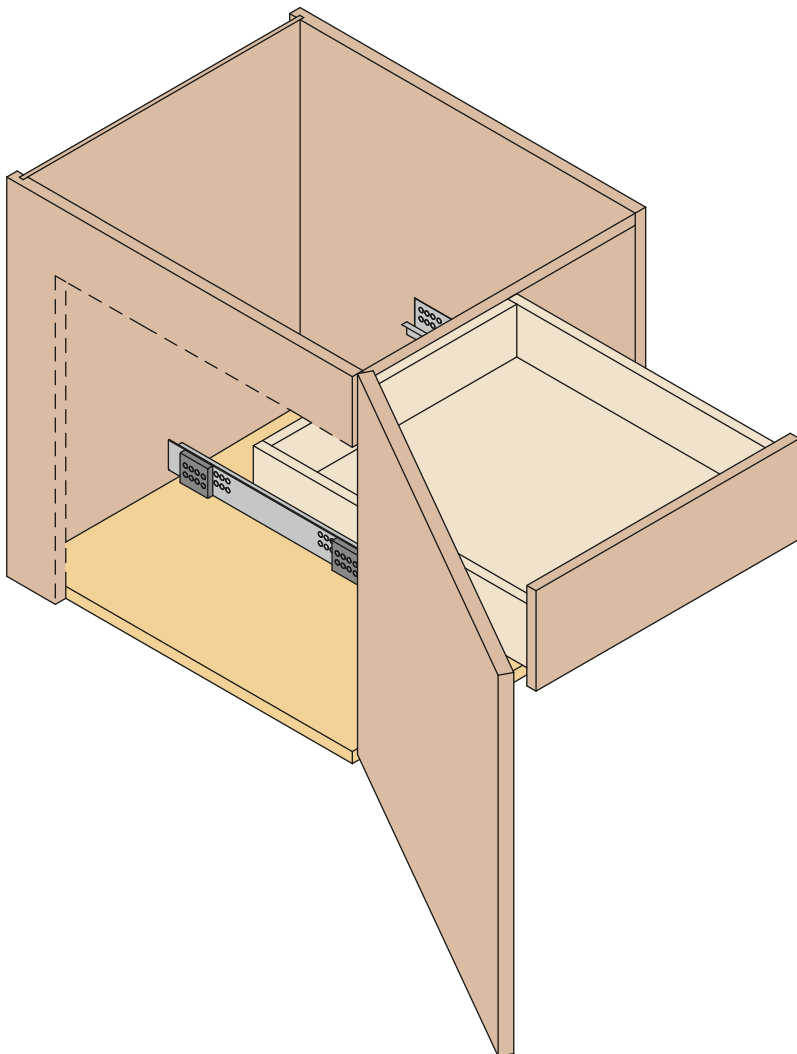

**Fixing screws
Vis de fixation****Wood screw
Vis à bois****V234X164I**

ø 4 x 16 mm

pre-drilling ø 2 x 2 mm
preperçage ø 2 x 2 mm

PACKAGING
1 box = 20.000 pcs

EMBALLAGE
1 carton = 20000 pièces

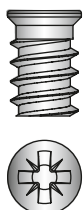
**Euro screws
Eurovis****V136X114I**

drilling ø 5 x 10 mm
perçage ø 5 x 10 mm

PACKAGING
1 box = 10.000 pcs

EMBALLAGE
1 carton = 10000 pièces

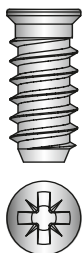
**V136X154I**

drilling ø 5 x 14 mm
perçage ø 5 x 14 mm

PACKAGING
1 box = 5.000 pcs

EMBALLAGE
1 carton = 5000 pièces

**Pozi driver
Tournevis Pozidrive****D2A7XCXCP**

PACKAGING
1 box = 100 pcs

EMBALLAGE
1 carton = 100 pièces