

Excessories - shelves - aluminium frame - electrical components

Code number	Transformer 24VDC - 10 outlets
VE80EAXA001XXA	MAX. 60W - 220/230V - MAX. 2,5A - EU
VE80EAXA002XXA	MAX. 120W - 220/230V - MAX. 5A - EU
VE80EBXA032XXA	MAX. 60W - 220/230V - MAX. 2,5A - UK
VE80EBXA033XXA	MAX. 120W - 220/230V - MAX. 5A - UK
VE80EBXA034XXA	MAX. 60W - 120V - MAX. 2,5A - USA
VE80EBXA035XXA	MAX. 96W - 120V - MAX. 4A - USA

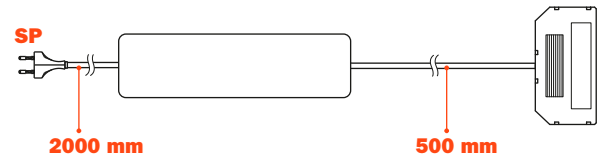

Code number	* Transformer with wireless control 24VDC - 10 outlets
VE80EAXA003XXA	MAX. 60W - 220/230V - MAX. 2,5A - EU
VE80EAXA004XXA	MAX. 120W - 220/230V - MAX. 5A - EU
VE80EBXA036XXA	MAX. 60W - 220/230V - MAX. 2,5A - UK
VE80EBXA037XXA	MAX. 120W - 220/230V - MAX. 5A - UK
VE80EBXA038XXA	MAX. 60W - 120V - MAX. 2,5A - USA
VE80EBXA039XXA	MAX. 96W - 120V - MAX. 4A - USA

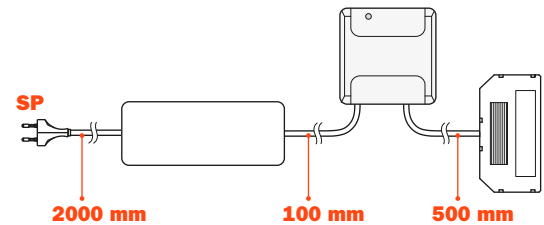

Code number	Wireless control
VE80EBXA001XXA	Wall mounted wireless control with dimmer function for light intensity and colour temperature. It transforms the standard buttons in wireless control.



Code number	Wireless control
VE80EBXA002XXA	Wireless control with central push button and dimmer function for light intensity. Dial control to vary colour temperature.

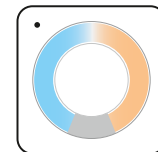

Code number	Wireless control
VE80EBXA003XXA	Recessed wireless touch control with dimmer function for light intensity and colour temperature



Code number	Wireless control
VE80EBXA004XXA	Wireless touch and PIR (Passive infrared) control with dimmer function for light intensity and colour temperature







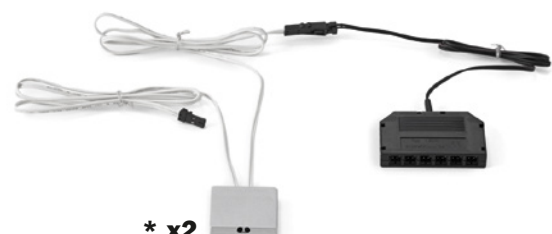

Code number	Wireless control
VE80EBXA010XXA	HUB for light control for smartphone, tablet or pc



Code number	IR (Infrared) sensor surface mounted for doors
VE80EBXA020XXA	MAX. 60W - 24 VDC - MAX. 2,5A - 1 door
VE80EBXA021XXA	MAX. 60W - 24 VDC - MAX. 2,5A - 2 doors*



* x2

-  EDC function (Emotion Dual Color): colour temperature varies from "warm" to "natural"
-  Dimmer function
-  Range: 15 m internal area
-  Battery type: CR2450
-  Estimated battery life: 3 years
-  * Compatible with transformer with wireless control receiver

- Transformer: 230V
- Type of communication: Wi-Fi
- Number of devices, smartphone, tablet or pc simultaneously connected: 50
- Number of manageable receivers: 20
- Protection level: IP20
- Function temperature: -20 +55°C
- Dimensions: 174x46x35 mm

Excessories - shelves - aluminium frame - electrical components

Application examples

Activation by domestic switch

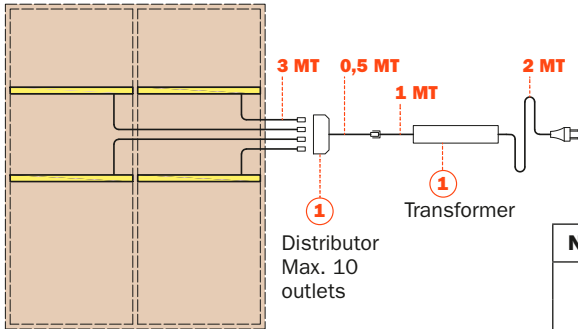

Nr.	Code Number	Description
1	VE80EAXA001XXA	24V 60W transformer, 10 outlets (1/1)
	VE80EAXA002XXA	24V 120W transformer, 10 outlets (1/9)
	VE80EBXA032XXA	220-240V 24VDC 60W SLIM transformer, 10 outlets SP, UK
	VE80EBXA033XXA	220-240V 24VDC 120W transformer, 10 outlets SP, UK
	VE80EBXA034XXA	120VAC/24VDC P=60W transformer, + 10 outlets +SP, NA
	VE80EBXA035XXA	120VAC/24VDC P=96W transformer, + 10 outlets +SP, NA

Activation by smart switch controller

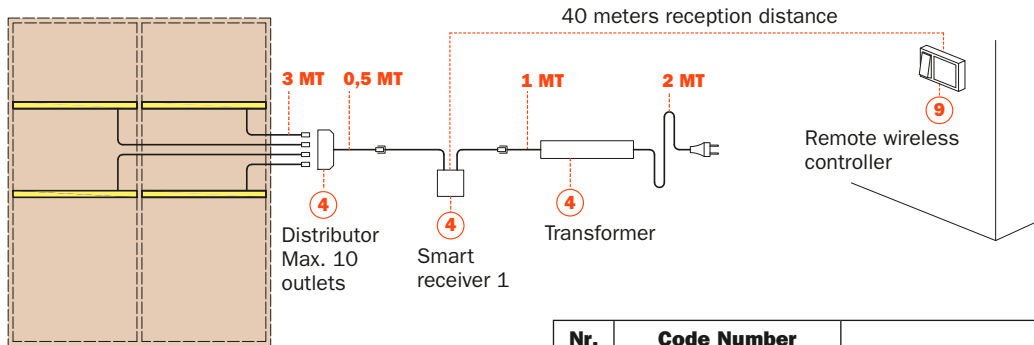

Nr.	Code Number	Description
4	VE80EAXA003XXA	24V 60W transformer, 10 outlets + receiver (1/1)
	VE80EAXA004XXA	24V 120W transformer, 10 outlets + receiver (1/1)
	VE80EBXA036XXA	SMART 1 EDC + DRIVER 60W 24V SP, UK
	VE80EBXA037XXA	SMART 1 EDC + DRIVER 120W 24V SP, UK
	VE80EBXA038XXA	SMART 1 EDC + DRIVER 60W 24V 120V SP, NA
	VE80EBXA039XXA	SMART 1 EDC + DRIVER 96W 24V 120V SP, NA
9	VE80EBXA001XXA	Remote wireless control (1/1)

Activation with 1 or 2 IR sensors - External

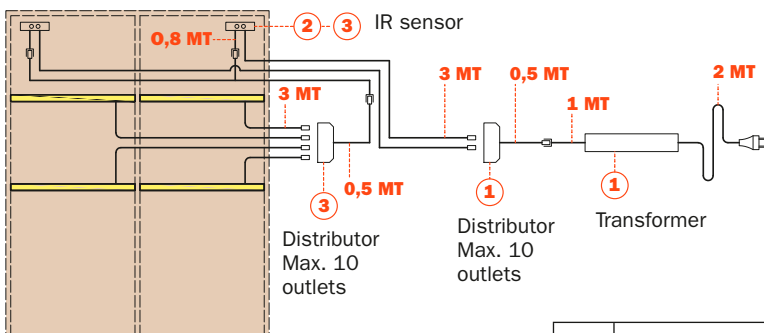

Nr.	Code Number	Description
1	VE80EAXA001XXA	24V 60W transformer, 10 outlets (1/1)
	VE80EAXA002XXA	24V 120W transformer, 10 outlets (1/1)
	VE80EBXA032XXA	220-240V 24VDC 60W SLIM transformer, 10 outlets SP, UK
	VE80EBXA033XXA	220-240V 24VDC 120W transformer, 10 outlets SP, UK
	VE80EBXA034XXA	120VAC/24VDC P=60W transformer, + 10 outlets +SP, NA
	VE80EBXA035XXA	120VAC/24VDC P=96W transformer, + 10 outlets +SP, NA
2	VE80EBXA020XXA	IR sensor surface mounted for 1 door (1/1)
3	VE80EBXA021XXA	IR sensor surface mounted for 2 doors (1/1)

Activation with 1 smart controller

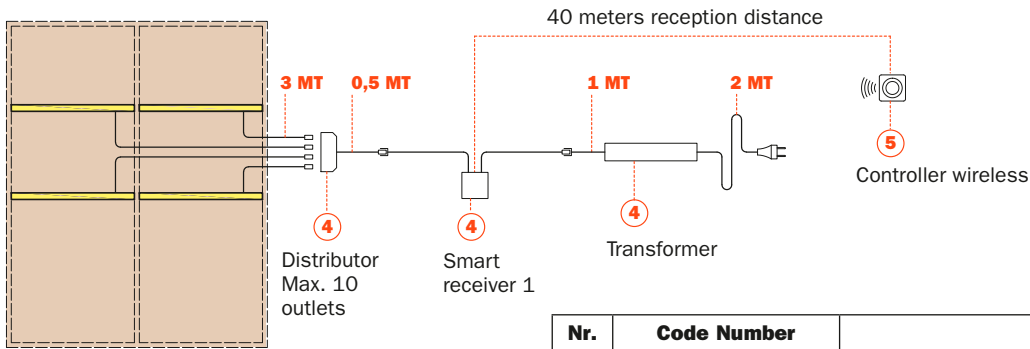

Nr.	Code Number	Description
4	VE80EAXA003XXA	24V 60W transformer, 10 outlets + receiver (1/1)
	VE80EAXA004XXA	24V 120W transformer, 10 outlets + receiver (1/1)
	VE80EBXA036XXA	SMART 1 EDC + DRIVER 60W 24V SP, UK
	VE80EBXA037XXA	SMART 1 EDC + DRIVER 120W 24V SP, UK
	VE80EBXA038XXA	SMART 1 EDC + DRIVER 60W 24V 120V SP, NA
	VE80EBXA039XXA	SMART 1 EDC + DRIVER 96W 24V 120V SP, NA
5	VE80EBXA002XXA	On/off wireless controller + Dimmer (1/1)

Activation with 1 smart touch or smart sensor controller

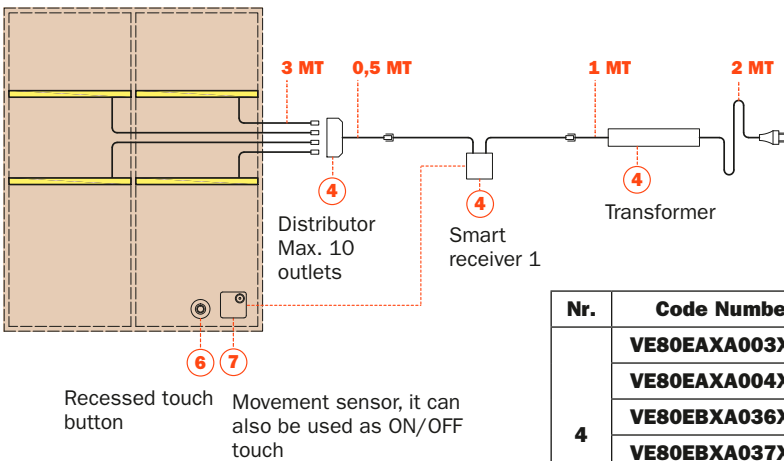

Nr.	Code Number	Description
4	VE80EAXA003XXA	24V 60W transformer, 10 outlets + receiver (1/1)
	VE80EAXA004XXA	24V 120W transformer, 10 outlets + receiver (1/1)
	VE80EBXA036XXA	SMART 1 EDC + DRIVER 60W 24V SP, UK
	VE80EBXA037XXA	SMART 1 EDC + DRIVER 120W 24V SP, UK
	VE80EBXA038XXA	SMART 1 EDC + DRIVER 60W 24V 120V SP, NA
	VE80EBXA039XXA	SMART 1 EDC + DRIVER 96W 24V 120V SP, NA
6	VE80EBXA003XXA	On/off recessed wireless controller + Dimmer (1/1)
7	VE80EBXA004XXA	On/off IR sensor + Dimmer (1/1)

Activation with Smart home gateway controller

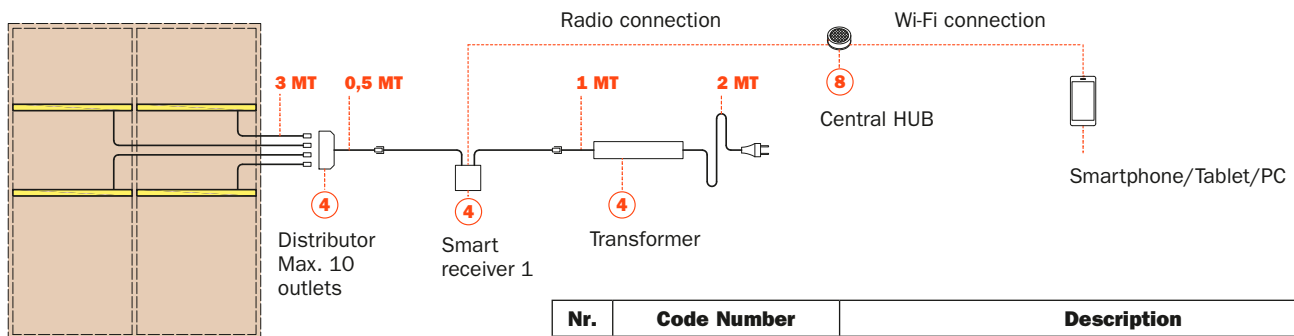

Nr.	Code Number	Description
4	VE80EAXA003XXA	24V 60W transformer, 10 outlets + receiver (1/1)
	VE80EAXA004XXA	24V 120W transformer, 10 outlets + receiver (1/1)
	VE80EBXA036XXA	SMART 1 EDC + DRIVER 60W 24V SP, UK
	VE80EBXA037XXA	SMART 1 EDC + DRIVER 120W 24V SP, UK
	VE80EBXA038XXA	SMART 1 EDC + DRIVER 60W 24V 120V SP, NA
	VE80EBXA039XXA	SMART 1 EDC + DRIVER 96W 24V 120V SP, NA
8	VE80EBXA010XXA	HUB for mobile controller (1/1)