

Excessories - pull-out - 3-sided drawer H 52 - for glass front

Aluminum 3-sided drawer H 52 GLASS FRONT H 75

- Profile height: 52 mm
- Max. drawer width: 1500 mm
- Material: epoxy-coated aluminum
- Finish: metal grey brown
- Equipped with full-extension Futura runners
- Integrated height and depth adjustments
- Equipped with anti-tipping device
- The drawers are supplied assembled complete with the gasket needed to hold in place the drawer bottom and accessories
- Glass front upon request, bottom not included
- Bottom can be made of wood or glass

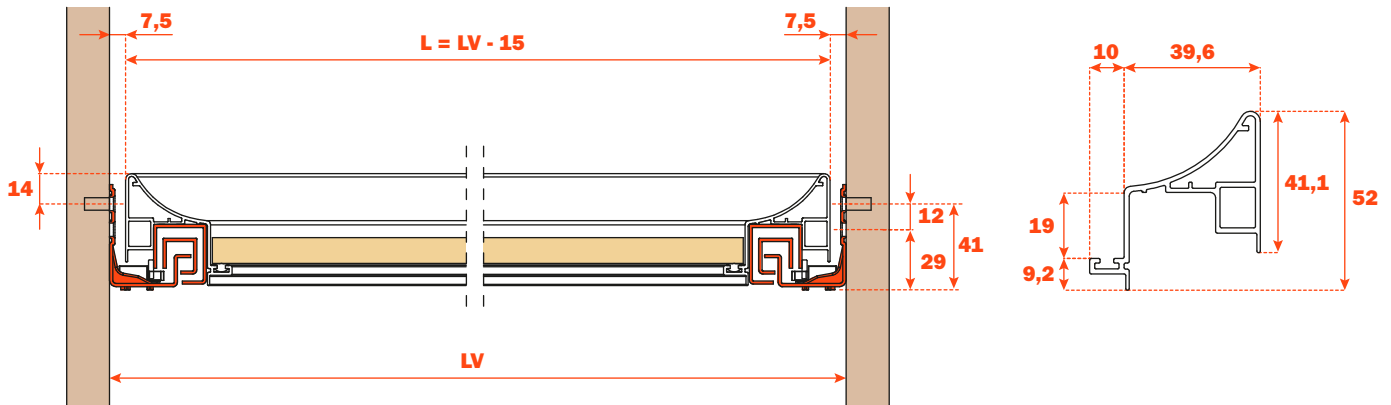

ASSEMBLY WITH ALUMINUM PROFILE 6 mm THICKNESS. ALIGNMENT WITH WOOD FRONT 12 mm THICKNESS

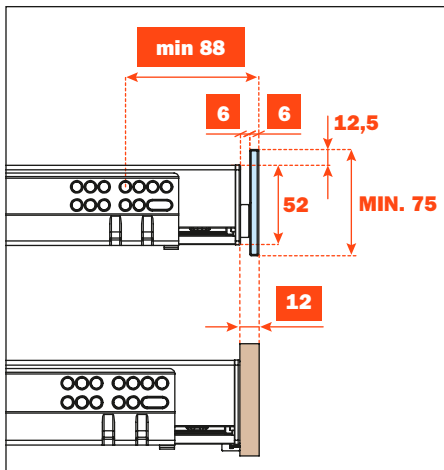

ASSEMBLY WITH ALUMINUM PROFILE 13 mm THICKNESS. ALIGNMENT WITH WOOD FRONT 19 mm THICKNESS

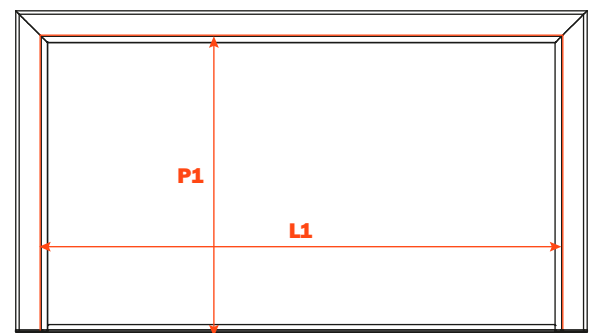
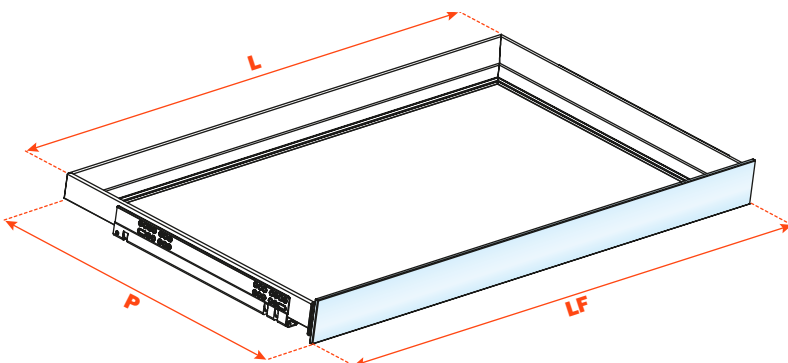
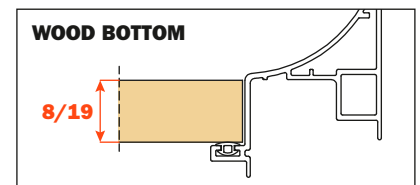
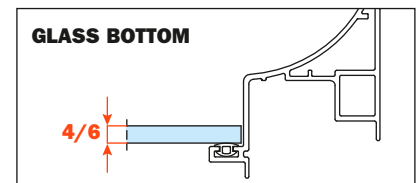
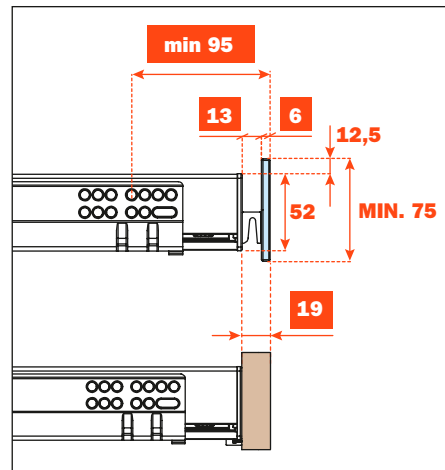

Kit for the front fixing (to be ordered separately)

1. M 4x10 mm screws
2. Fixing caps
3. Aluminum profile with adhesive tape for fixing on the front

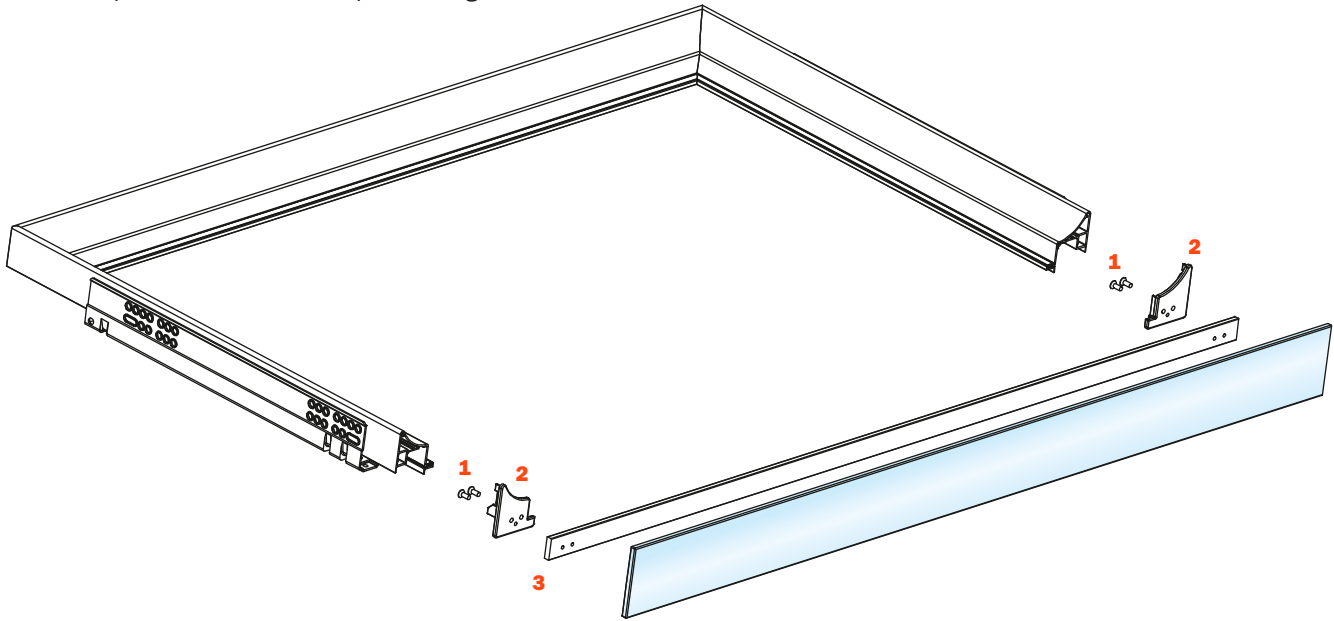

Fixing the profile to the front

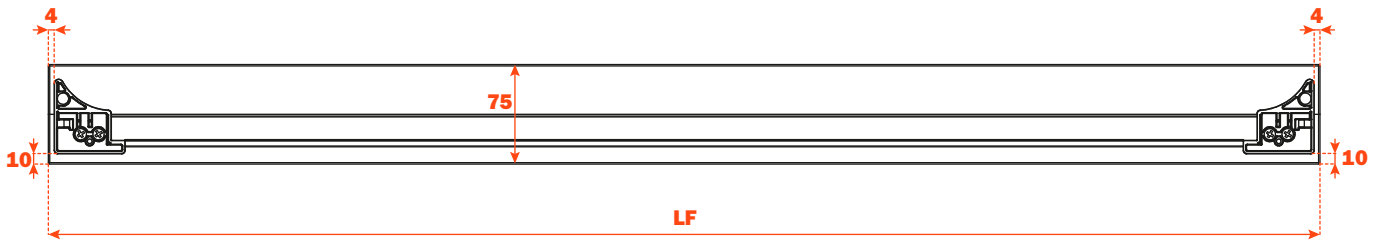

GLASS FRONT, 6 mm THICKNESS - ALUMINUM PROFILE, 6 mm THICKNESS

Runner length (LN) mm	Drawer width (L) mm	Front width (LF) mm	Internal width (L1) mm	Drawer depth (P) mm	Internal depth (P1) mm
350	LV - 15	LV - 6	L - 80	390	338
400				440	388
450				490	438
470				510	458
500				547	488

GLASS FRONT, 6 mm THICKNESS - ALUMINUM PROFILE, 13 mm THICKNESS

Runner length (LN) mm	Drawer width (L) mm	Front width (LF) mm	Internal width (L1) mm	Drawer depth (P) mm	Internal depth (P1) mm
350	LV - 15	LV - 6	L - 80	397	338
400				447	388
450				497	438
470				517	458
500				547	488