

Excessories - pull-out - 3-sided drawer H 52 - for glass frontal

Aluminium 3-sided drawer H 52 GLASS FRONTAL H 75

- Profile height: 52 mm
- Max. drawer width: 1500 mm
- Material: aluminium coated with epoxy-based powder
- Finish: metal grey brown
- Equipped with full-extension Futura runners
- Integrated height and depth adjustments
- Equipped with anti-tipping device
- The drawers are supplied assembled complete with the gasket needed to hold in place the drawer bottom and accessories
- Glass frontal upon request, bottom not included
- Bottom can be made of wood or glass

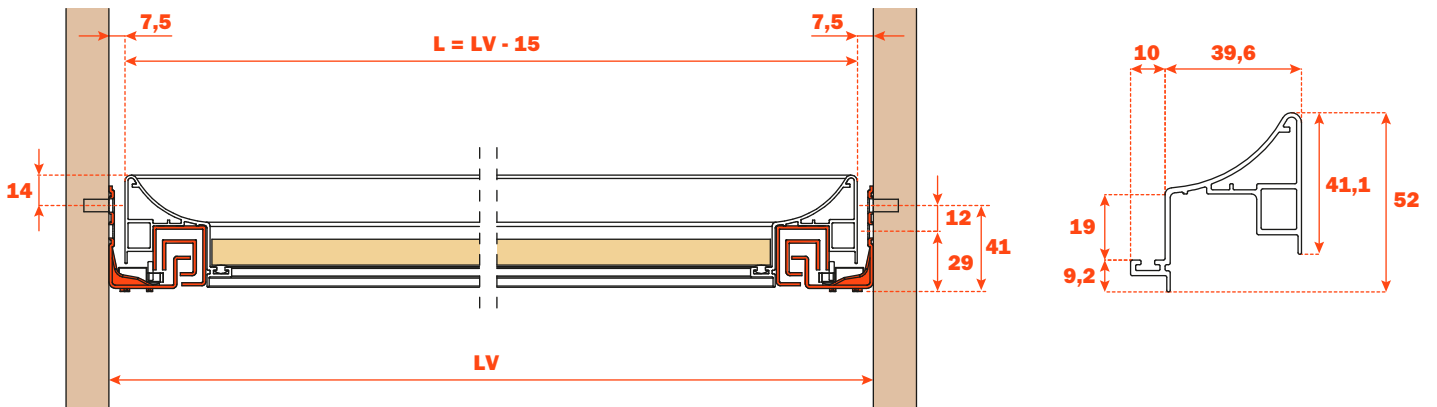

ASSEMBLY WITH ALUMINIUM PROFILE 6 mm THICKNESS. ALIGNMENT WITH WOODEN FRONTAL 12 mm THICKNESS

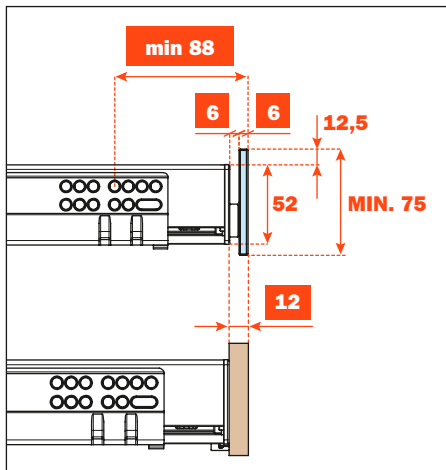

ASSEMBLY WITH ALUMINIUM PROFILE 13 mm THICKNESS. ALIGNMENT WITH WOODEN FRONTAL 19 mm THICKNESS

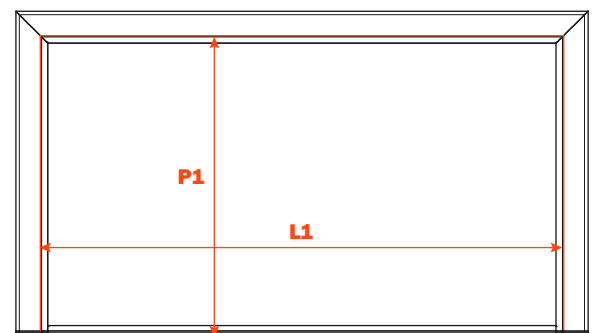
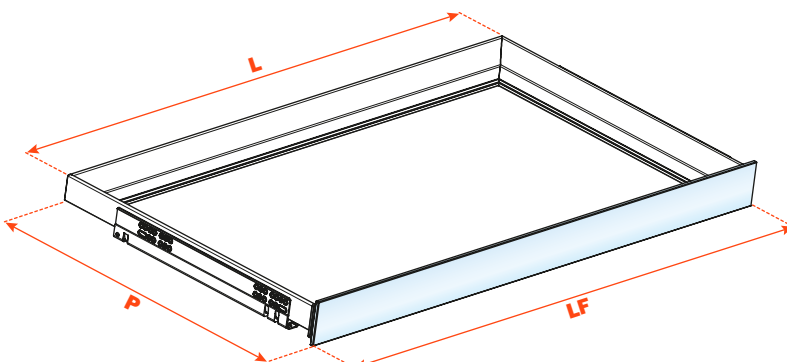
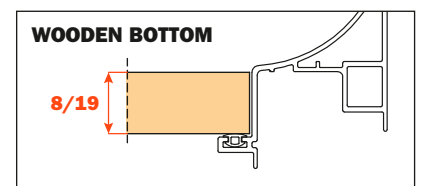
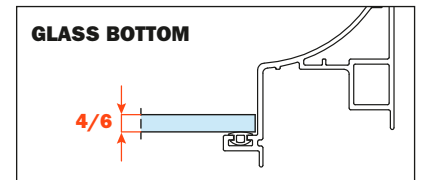
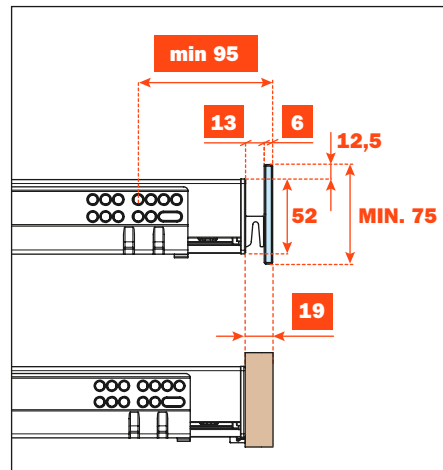

Kit for the frontal fixing (to be ordered separately)

1. M 4x10 mm screws
2. Fixing caps
3. Aluminium profile with adhesive tape for fixing on the frontal

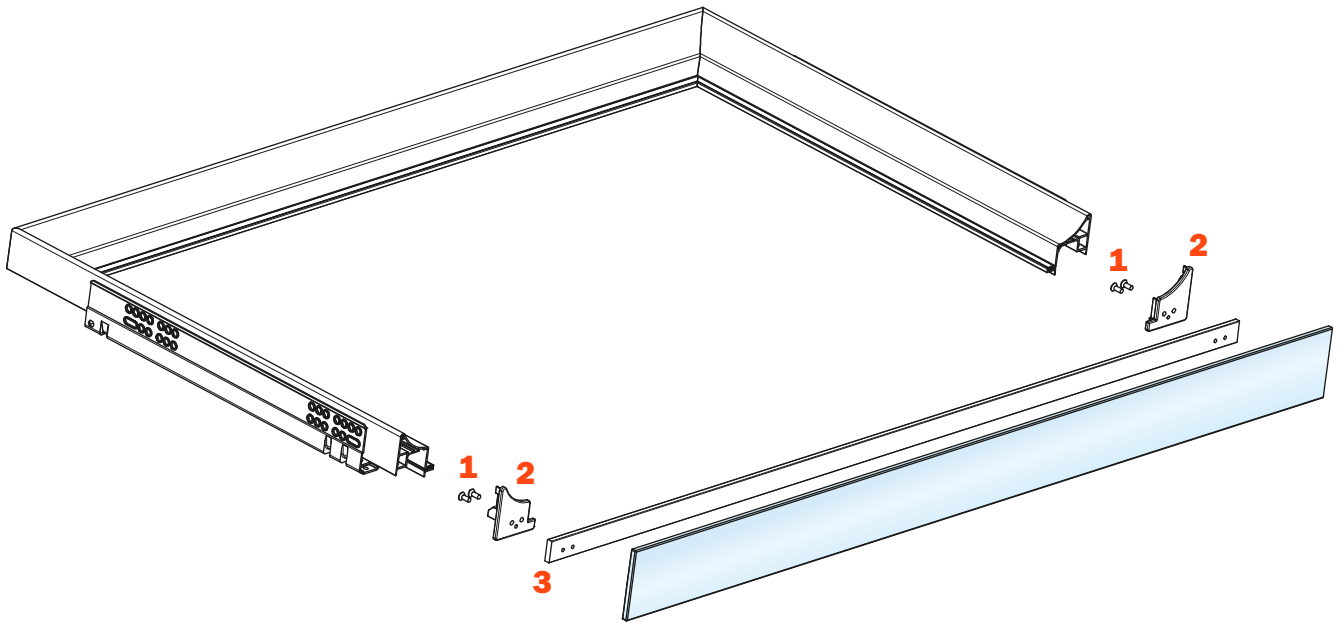

Fixing the profile to the frontal

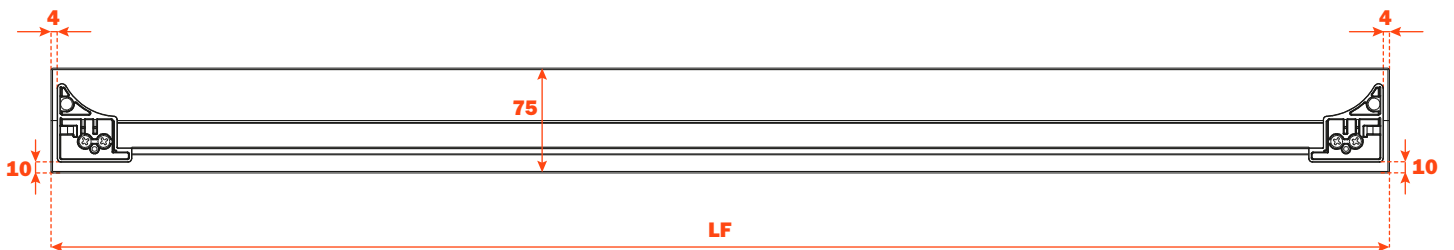

GLASS FRONTAL, 6 mm THICKNESS - ALUMINIUM PROFILE, 6 mm THICKNESS

Runner length (LN) mm	Drawer width (L) mm	Frontal width (LF) mm	Internal width (L1) mm	Drawer depth (P) mm	Internal depth (P1) mm
350	LV - 15	LV - 6	L - 80	390	338
400				440	388
450				490	438
470				510	458

GLASS FRONTAL, 6 mm THICKNESS - ALUMINIUM PROFILE, 13 mm THICKNESS

Runner length (LN) mm	Drawer width (L) mm	Frontal width (LF) mm	Internal width (L1) mm	Drawer depth (P) mm	Internal depth (P1) mm
350	LV - 15	LV - 6	L - 80	397	338
400				447	388
450				497	438
470				517	458