

Excessories - pull-out - 3-sided drawer H 52 - for wooden frontal

Aluminium 3-sided drawer H 52 WOODEN FRONTAL H 75

- Profile height: 52 mm
- Max. drawer width: 1500 mm
- Material: aluminium coated with epoxy-based powder
- Finish: metal grey brown
- Equipped with full-extension Futura runners
- Integrated height and depth adjustments
- Equipped with anti-tipping device
- The drawers are supplied assembled complete with the gasket needed to hold in place the drawer bottom and accessories
- Frontal and bottom not included
- Bottom can be made of wood or glass

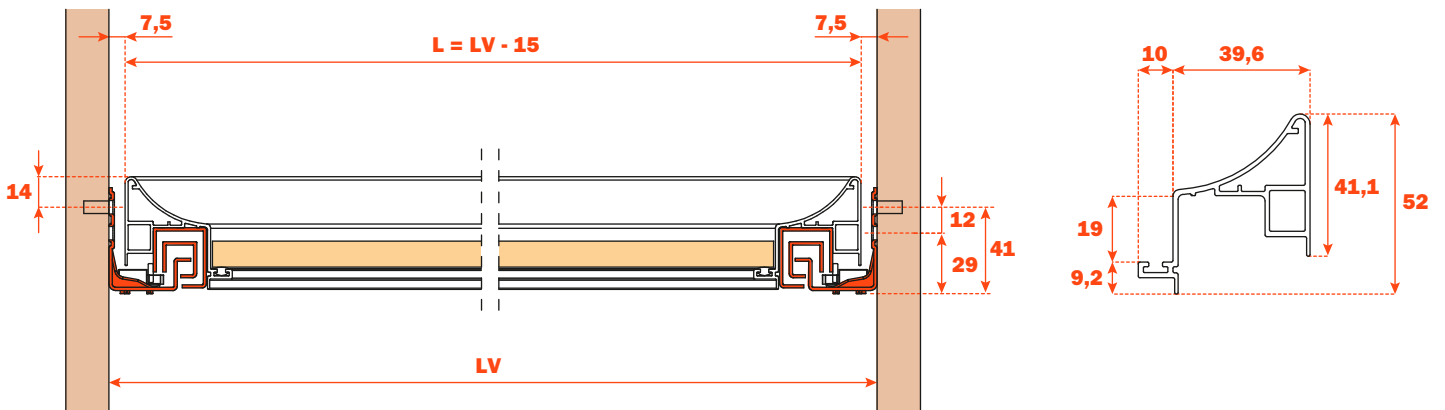

ASSEMBLY WITH WOODEN FRONTAL, 12 mm THICKNESS

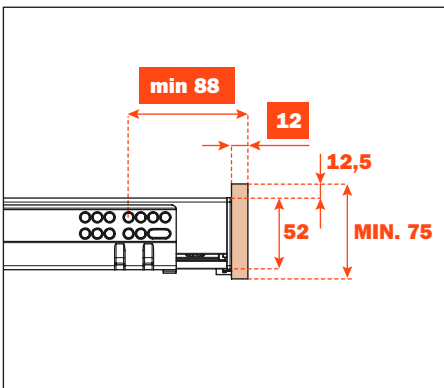

ASSEMBLY WITH WOODEN FRONTAL, 19 mm THICKNESS

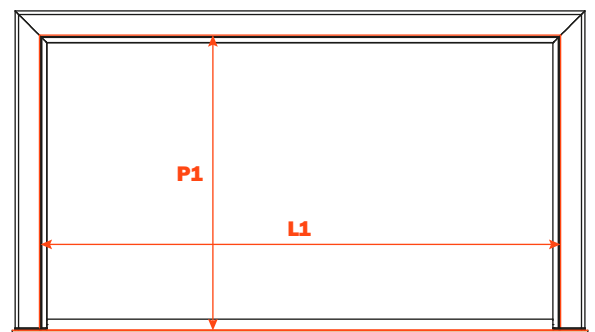
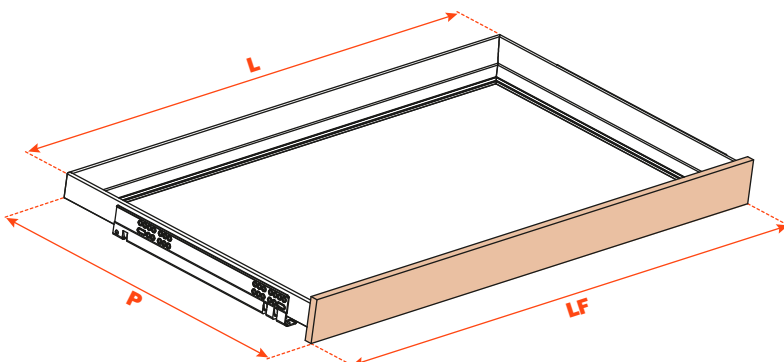
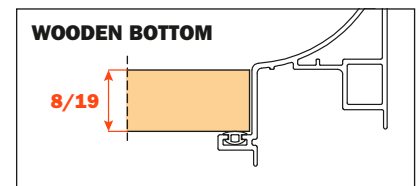
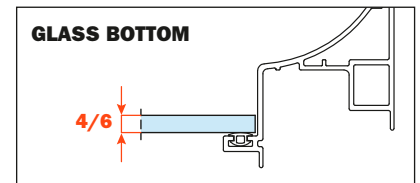
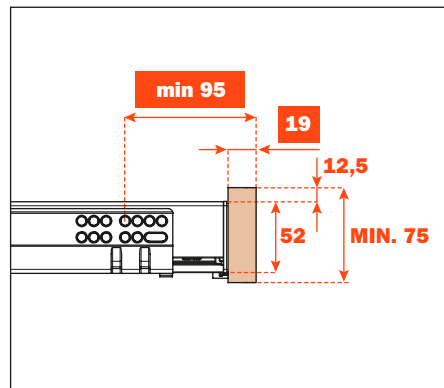

Kit for the frontal fixing (to be ordered separately)

1. 6,3x14 mm TPSV Euro screws
2. Fixing caps
3. Aluminium profile
4. Connecting elements

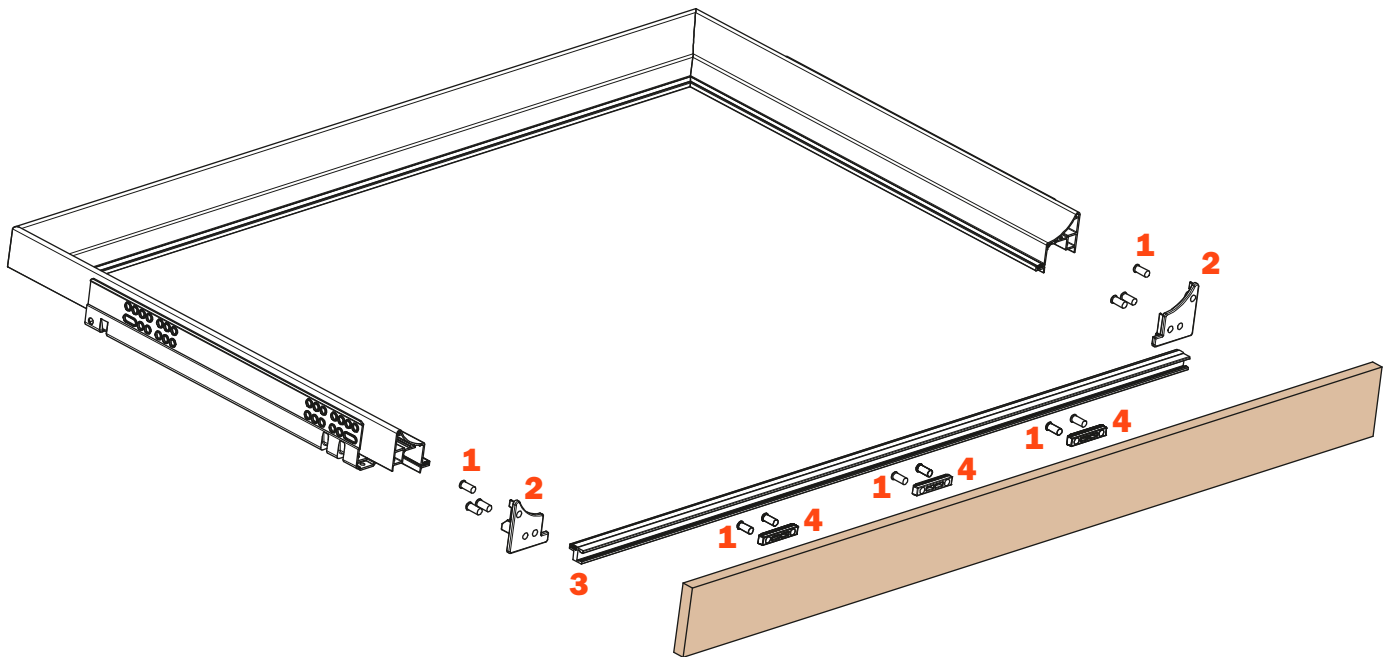

Frontal drilling

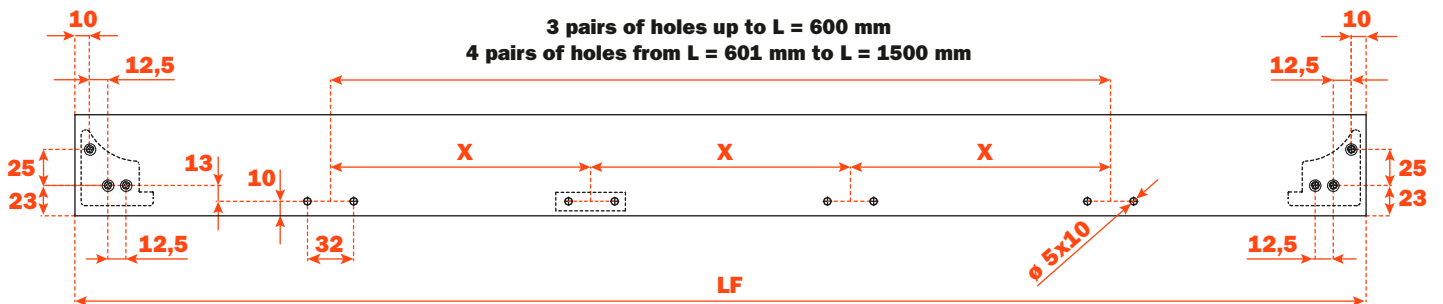

Runner length (LN) mm	Drawer width (L) mm	Frontal width (LF) mm	Internal width (L1) mm	Drawer depth (P) mm + wooden frontal 12 mm	Drawer depth (P) mm + wooden frontal 19 mm	Internal depth (P1) mm
350	LV - 15	LV - 6	L - 80	390	397	338
400				440	447	388
450				490	497	438
470				510	517	458