

# Split - Contenedores

## ADC02\_X367X150

- Provisto de patas antideslizantes.
- Dimensiones externas (mm) 367x150 H 70.5
- Embalaje: caja de 1 pieza

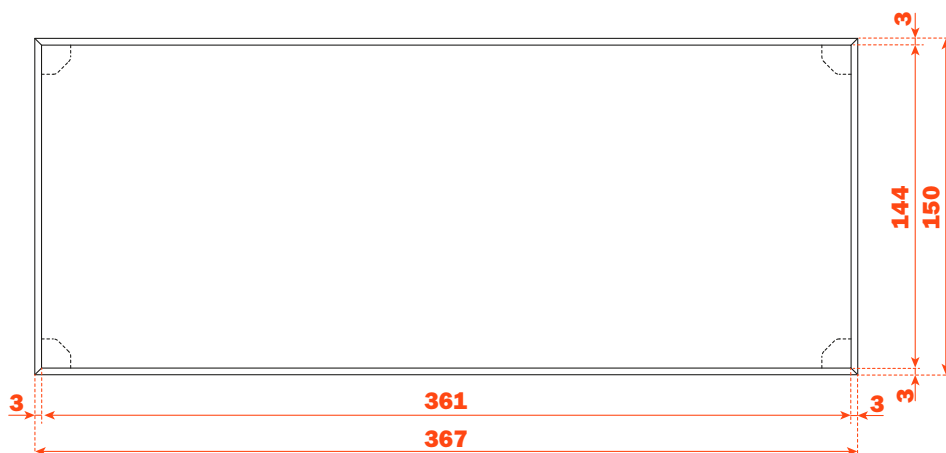
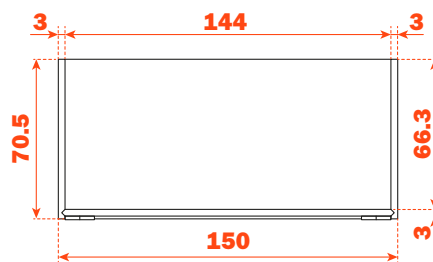
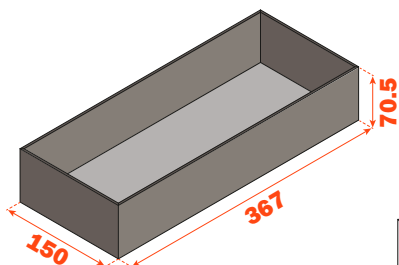

## ADC03\_X267X150

- Provisto de patas antideslizantes.
- Dimensiones externas (mm) 267x150 H 88.5
- Embalaje: caja de 1 pieza

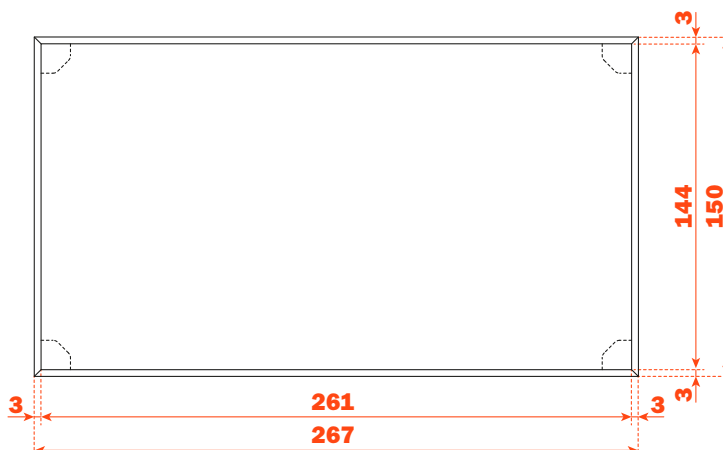
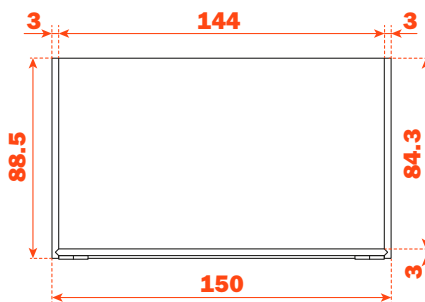
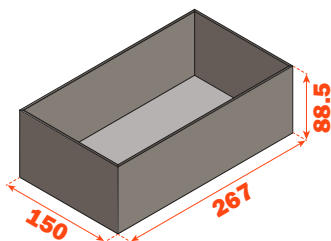

# Split - Contenedores

## ADC03\_X300X100

- Contenedor suministrado con 2 separadores internos extraíbles.  
Separadores internos opcionales de aluminio bajo petición.
- Provisto de patas antideslizantes.
- Dimensiones externas (mm) 300x100 H 88.5
- Embalaje: caja de 1 pieza

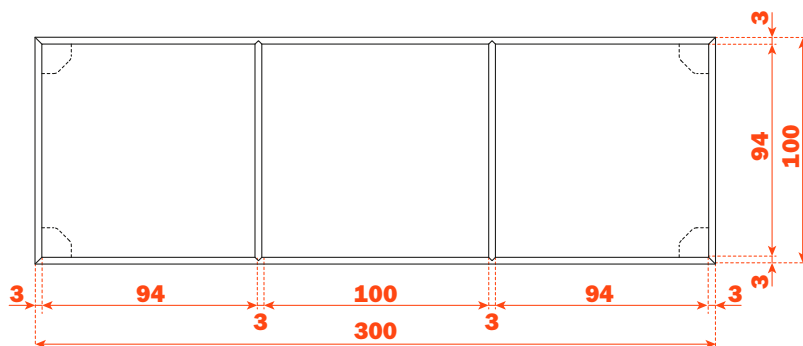
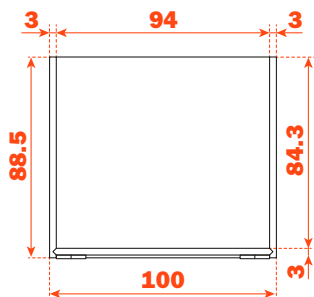
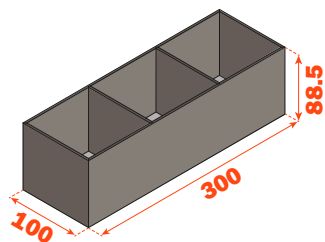

## ADC03\_X300X150

- Contenedor suministrado con 2 separadores internos extraíbles.  
Separadores internos opcionales de aluminio bajo petición.
- Provisto de patas antideslizantes.
- Dimensiones externas (mm) 300x150 H 88.5
- Embalaje: caja de 1 pieza

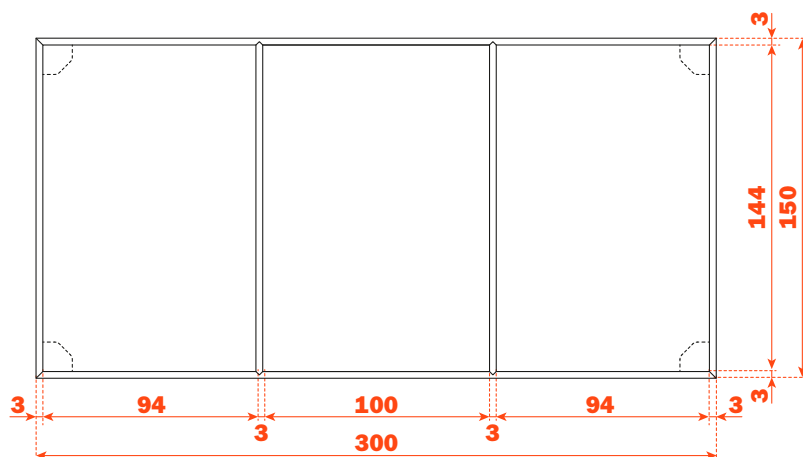
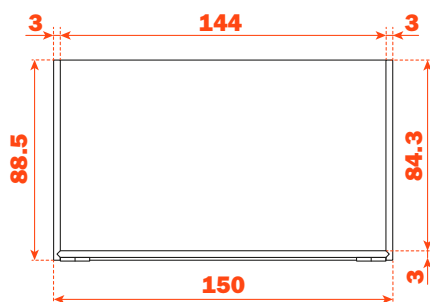
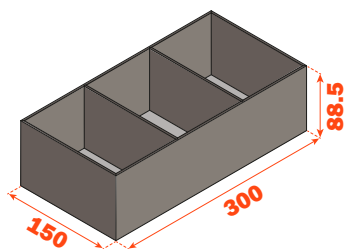

# Split - Contenedores

## ADC03\_X317X150

- Provisto de patas antideslizantes.
- Dimensiones externas (mm) 317x150 H 88.5
- Embalaje: caja de 1 pieza

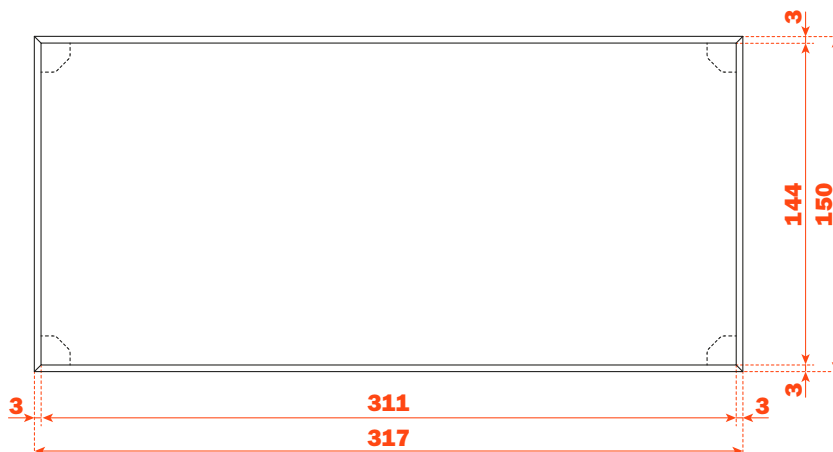
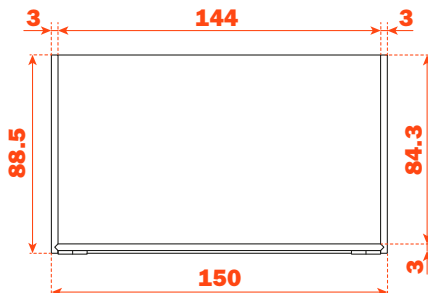
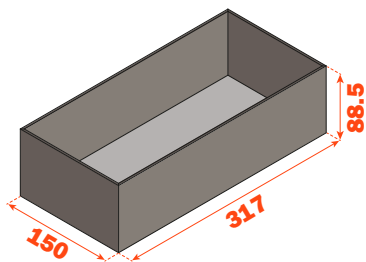

## ADC03\_X367X150

- Provisto de patas antideslizantes.
- Dimensiones externas (mm) 367x150 H 88.5
- Embalaje: caja de 1 pieza

