

# Split - Schubladen-Inneneinteilungssystem

## ADC02\_X367X150

- Rutschhemmende Füßchen
- Aussenmaße (mm) 367x150 H 70.5
- Verpackung: Schachtel mit 1 Stück

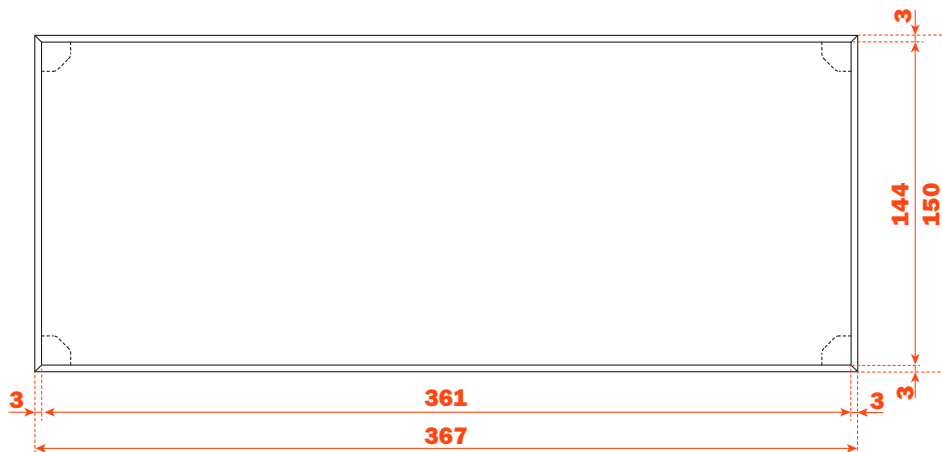
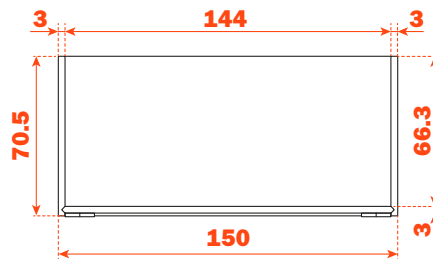
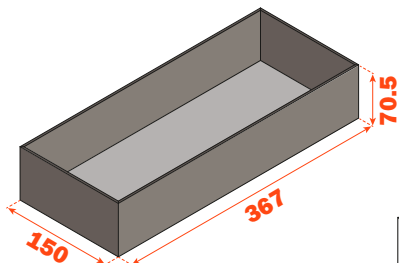

## ADC03\_X267X150

- Rutschhemmende Füßchen
- Aussenmaße (mm) 267x150 H 88.5
- Verpackung: Schachtel mit 1 Stück

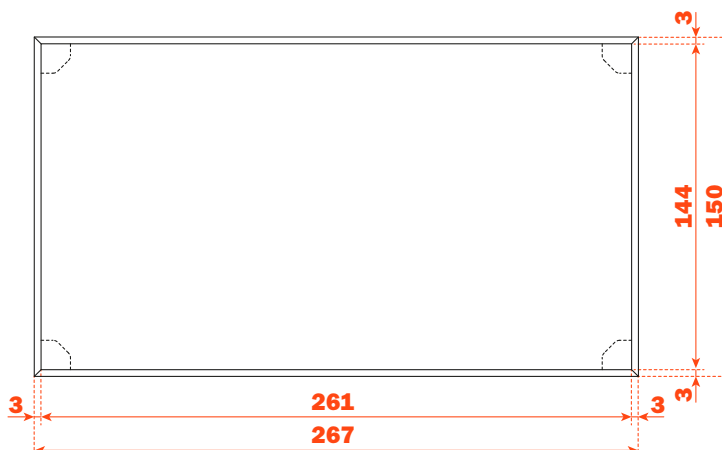
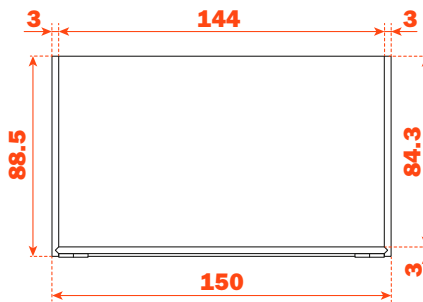
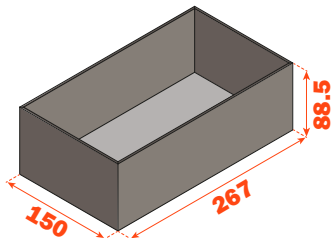

# Split - Schubladen-Inneneinteilungssystem

## ADC03\_X300X100

- Einsatzbox, wird mit 2 steckbaren Trennelementen geliefert  
Optionale internes Trennelement aus Aluminium, separat zu bestellen
- Rutschhemmende Füßchen
- Aussenmaße (mm) 300x100 H 88.5
- Verpackung: Schachtel mit 1 Stück

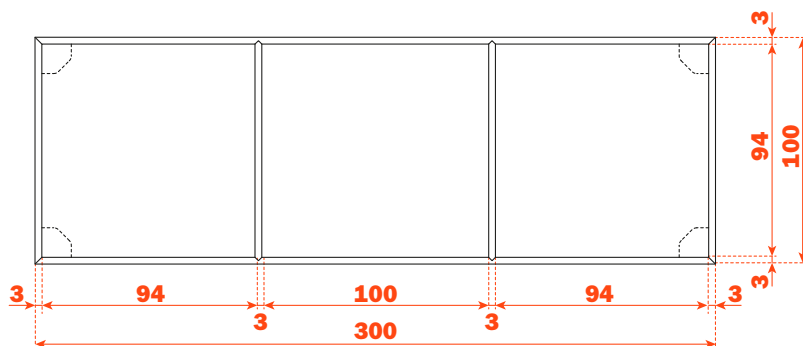
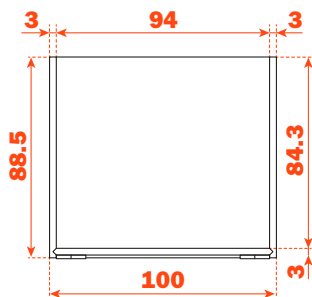
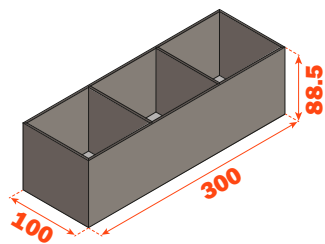

## ADC03\_X300X150

- Einsatzbox, wird mit 2 steckbaren Trennelementen geliefert  
Optionale internes Trennelement aus Aluminium, separat zu bestellen
- Rutschhemmende Füßchen
- Aussenmaße (mm) 300x150 H 88.5
- Verpackung: Schachtel mit 1 Stück

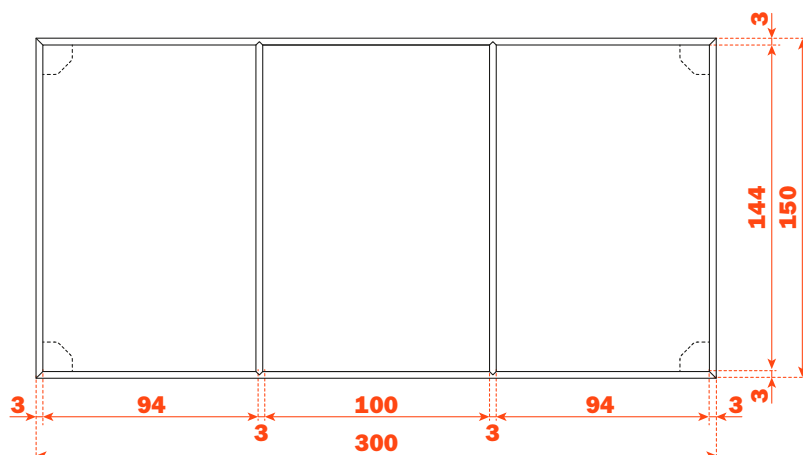
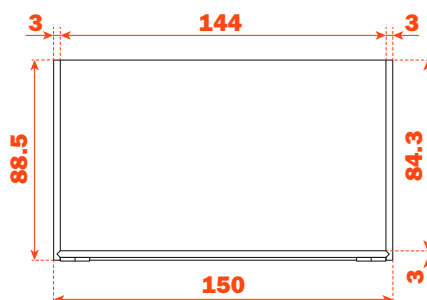
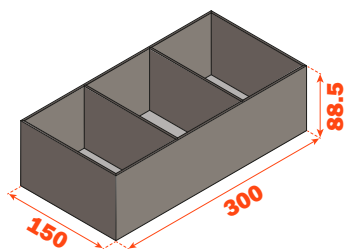

# Split - Schubladen-Inneneinteilungssystem

## ADC03\_X317X150

- Rutschhemmende Füßchen
- Aussenmaße (mm) 317x150 H 88.5
- Verpackung: Schachtel mit 1 Stück

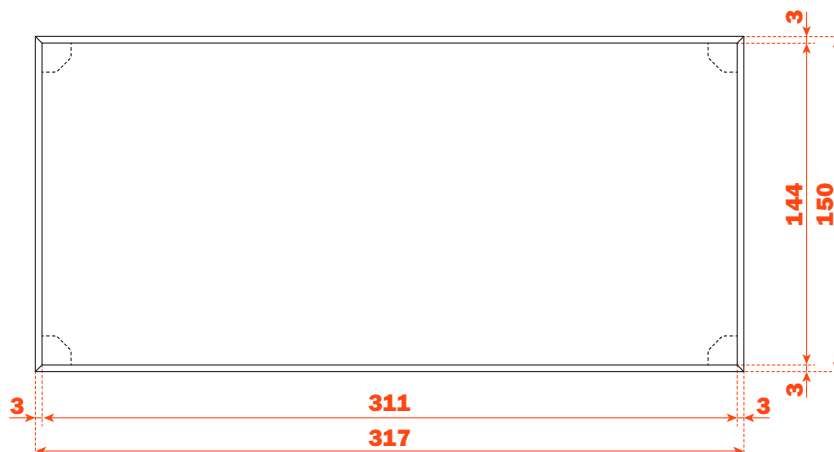
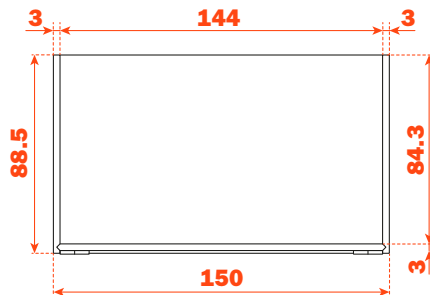
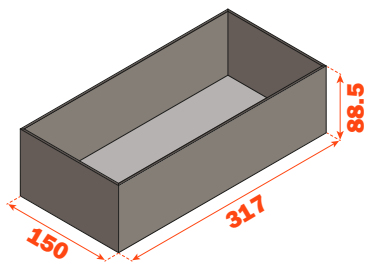

## ADC03\_X367X150

- Rutschhemmende Füßchen
- Aussenmaße (mm) 367x150 H 88.5
- Verpackung: Schachtel mit 1 Stück

