

# Lineabox - 2-sided - H 180 mm

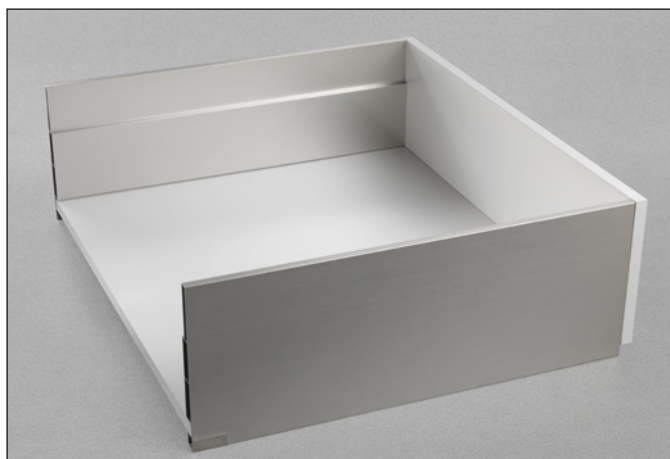

**Lineabox metal sides, wooden frontal and back panel.**  
**Height of the side 180 mm - Internal height 148 mm.**  
**For use with Futura full-extension runners: 655 - 6557 - 6555**  
**(consult the general catalogue "Runners and drawers").**

- Rapid assembly system, with no machinery or templates needed.
- Rapid mounting and removal of drawer frontal.
- Height, sideways and depth adjustment of the drawer incorporated in the runner fixing clips.
- Bottom thickness:
  - 16 mm
  - 15 mm with insert SMGP15X4XA
- Material: Aluminium
- Sides: 90° cut end
- Finishes:
  - Stainless steel
  - Champagne
  - Titanium
  - White

## Dimensions with Futura full-extension runners

## Thickness of the metal side

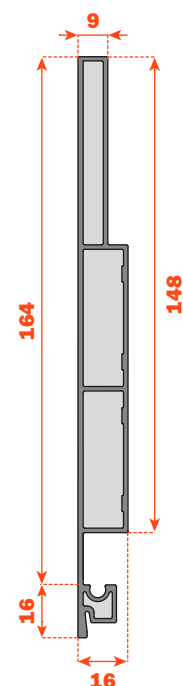
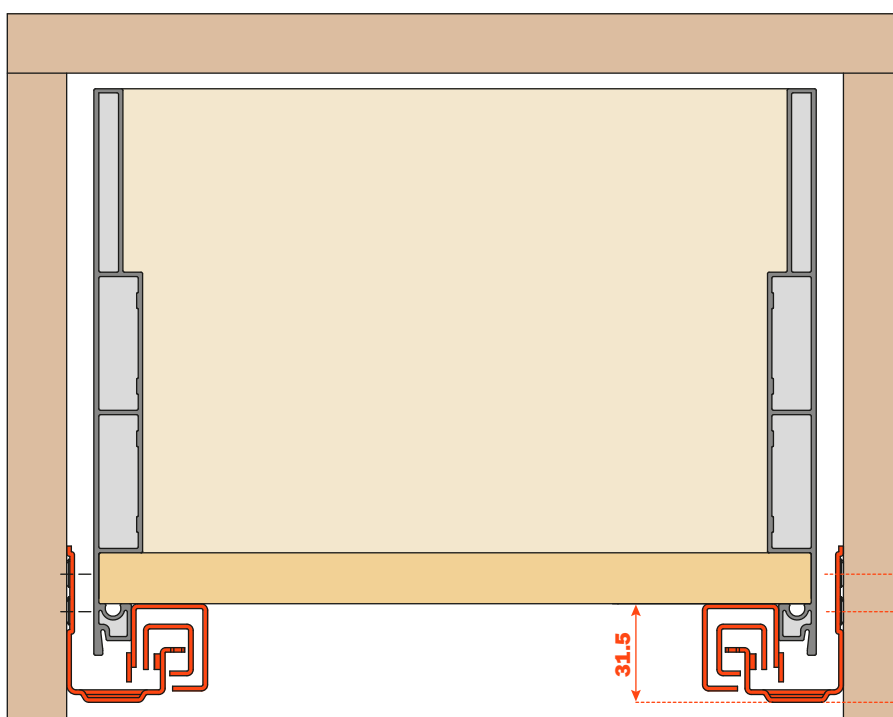

## Cutting the sides

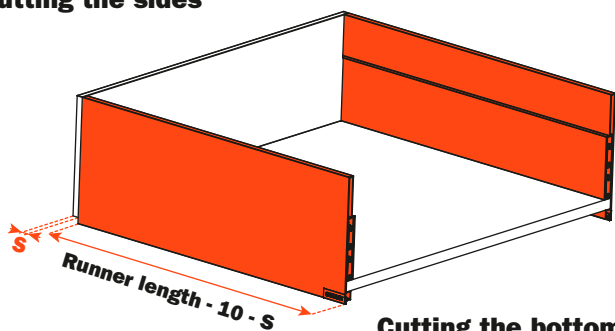

## Cutting the back

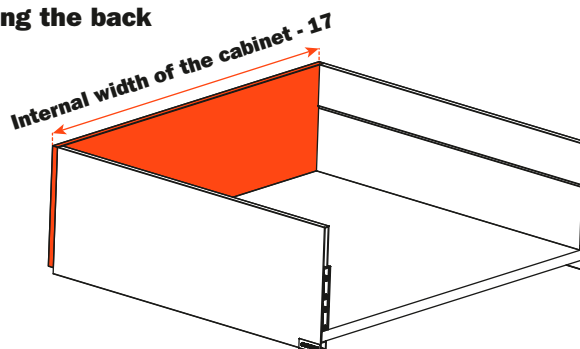

## Cutting the bottom

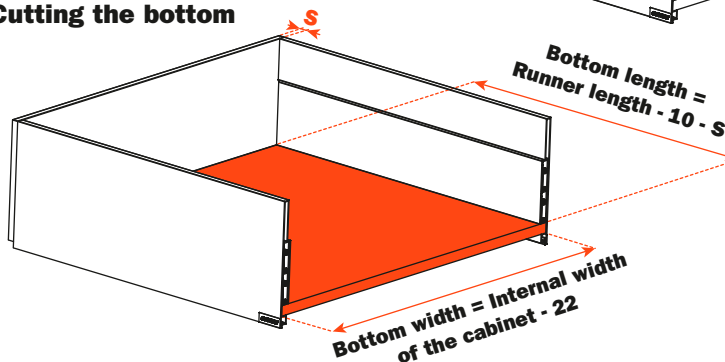

Frontal drilling

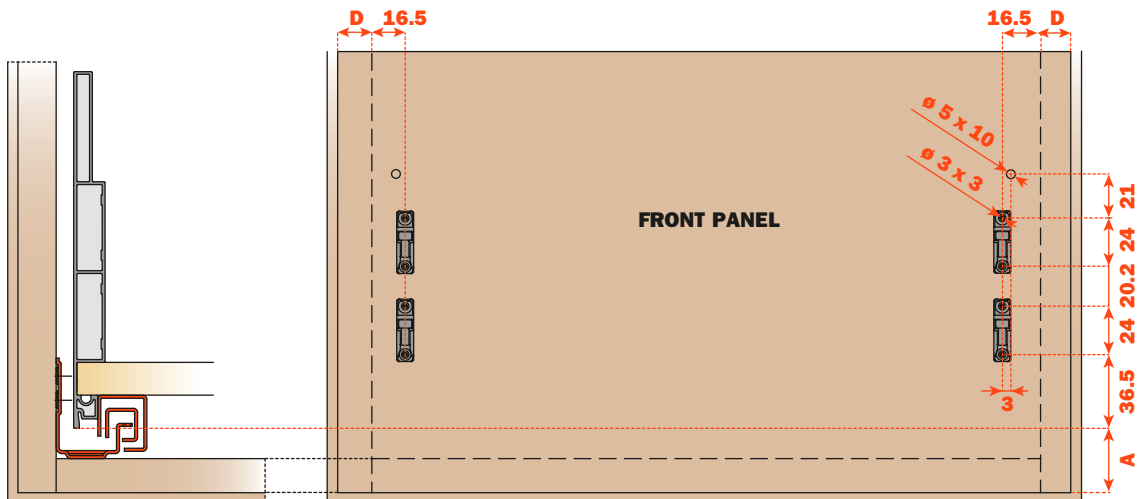

Back drilling



Elements of the drawer

- |                                                                                                                                                                                                                                                                                                                                                                       |                                                                                               |
|-----------------------------------------------------------------------------------------------------------------------------------------------------------------------------------------------------------------------------------------------------------------------------------------------------------------------------------------------------------------------|-----------------------------------------------------------------------------------------------|
| <p><b>1</b> Frontal connecting fitting <b>AMGPXA3</b></p> <p><b>2</b> Frontal fixing <b>SMGP12A3XA</b></p> <p><b>3</b> Cover cap<br/>(With embossed logo <b>SCCX83H9</b> - With silk-screen printed logo <b>SCXX83H9</b>)</p> <p><b>4</b> Stabilizer pin for 2-sided drawers <math>\phi</math> 6 mm<br/>Frontal drilling <math>\phi</math> 5 mm <b>SMGP21X4XA</b></p> | <p>Nr. 8 pcs.</p> <p>Nr. 8 pcs.</p> <p>Nr. 2 pcs. (optional)</p> <p>Nr. 2 pcs. (optional)</p> |
|-----------------------------------------------------------------------------------------------------------------------------------------------------------------------------------------------------------------------------------------------------------------------------------------------------------------------------------------------------------------------|-----------------------------------------------------------------------------------------------|

